

www.fabarm.com

# FABARM



SAISON 2007



# Index

FACTORY.....	2
<b>EXPRESS RIFLE</b>	
ASPER PRESTIGE.....	6
ASPER .....	8
<b>SIDE BY SIDE</b>	
NOBILE GRADE III.....	10
NOBILE GRADE II.....	12
BETA GRADE IV.....	14
CLASSIS 20.....	16
CLASSIS 12.....	18
<b>OVER &amp; UNDER - HUNTING LINE</b>	
AXIS FIELD 20 – AXIS FIELD 28.....	20
AXIS AL 20 – AXIS AL 28.....	22
FEATURES & BENEFITS AXIS 12.....	24
AXIS FIELD 12.....	28
AXIS AL 12.....	30
GAMMA 2.....	32
WATERFOWL – ALPHA.....	34
<b>OVER &amp; UNDER - SHOOTING LINE</b>	
AXIS SPORTING.....	38
AXIS TRAP.....	40
STL VS SPORTING.....	42
GAMMA 2 SPORTING & TRAP.....	44
<b>SEMI AUTO</b>	
FEATURES & BENEFITS.....	46
LION H35 EXCLUSIVE.....	50
LION H35 AZUR.....	52
LION H35 TITAN.....	54
LION H38 LUXE.....	56
LION H38 HUNTER.....	58
LION H38 THE SPECIALISTS.....	60
LION H368 COMPOSITE & CAMO.....	62
SEMI-AUTO LEFT HANDED.....	64
<b>CHOKE TUBES.....</b>	<b>66</b>
<b>HOME DEFENCE-LAW ENFORCEMENT</b>	
SEMI AUTO S.A.T. 8.....	68
PUMP PRO.....	70
SDASS.....	72
MARTIAL.....	74
<b>ACCESSORIES</b>	
MOUNTS – PADS – MUZZLE BREAK.....	76
GUN OIL & CLEANER.....	77
GUNSLIPS.....	78
GUN CASES.....	79
SHOOTING VESTS & CAPS.....	80



FACTORY

QUALITY

RESEARCH

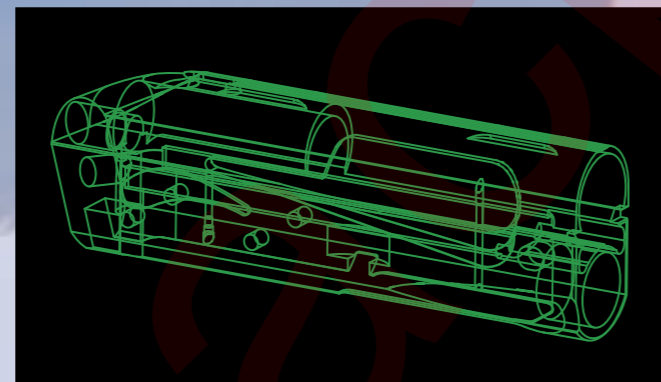

# CONCEPT GUNS



AXIS VINTAGE - 2005



LION H35 FUTURIS - 2004



RS07 - 2006



RS07 - 2006

◀ PURE EXPLORATION IN STYLE ▶

BY FABARM

# HUNTING LINE



EXPRESS  
SIDE BY SIDE  
OVER & UNDER  
SEMI-AUTO

**GB** You're a hunter with a distinctive sense of style, you are looking for an innovative double express rifle, lightweight, reliable ... For you there is the FABARM ASPER. Made in co-operation with a very famous German company at Suhl, the ASPER rifle is a reference in terms of accuracy. The barrel is the result of more than 100 years of know-how. It is machined from hammer-forged steel and has an exclusive scope mount system. The forged steel receiver with a deep engraving has a beautiful silver nitrite finish. Luxus wood with oil finish. The ASPER PRESTIGE includes a handsome, fitted ESTHETE™ case with a specific space for scope.

**I** Per un cacciatore che si distingue nello stile ed alla ricerca di un fucile express innovativo, leggero ed affidabile...c'è il FABARM ASPER. Fabbricato in cooperazione con una rinomata fabbrica tedesca di Suhl, l'ASPER è un termine di riferimento per la sua precisione di tiro. La canna, risultato di oltre 100 anni di esperienza, è realizzata con martellatura a freddo ed ha un esclusivo sistema di montaggio per ottica. La bascula in acciaio forgiato e finitura argento vecchio presenta una profonda incisione. Legni pregiati finiti ad olio. L'ASPER PRESTIGE è fornito di specifica valigetta ESTHETE™, con sede per ottica.

**F** Vous êtes un chasseur précis et exigeant, vous recherchez une carabine express innovante, légère, fiable...pour vous il y a la FABARM ASPER. Fabriquée en coopération avec une très célèbre marque Allemande de Suhl, l'ASPER est une référence en terme de précision. Le canon, résultat de plus de 100 années de savoir-faire, est réalisé par martelage à froid et possède un système de montage d'optique exclusif. La bascule en acier forgé est profondément gravée avec une belle finition vieil argent. Bois Luxe avec finition à l'huile. L'ASPER PRESTIGE comprend une valise ESTHETE™ faite main sur-mesure ayant un espace pour une lunette de visée.

**E** Para un cazador que busca un rifle express distinto, elegante e innovador le ofrecemos el nuevo rifle FABARM ASPER. Fabricado en cooperación con un renombrado fabricante alemán de Suhl, el Rifle ASPER es la referencia en términos de precisión. El cañón es el resultado de más de 100 años de experiencia y conocimiento, mecanizado a partir de acero forjado y un sistema de montaje exclusivo para los elementos de óptica. La bascula de acero forjado esta embellecida con un elegante y profundo grabado : Madera de lujo acabado al aceite. El rifle ASPER PRESTIGE es suministrado con un elegante estuche ESTHETE™ con un compartimento especial para el visor.

**P** Você é um caçador exigente e com sentido estético, procura uma carabina express inovadora, ligeira, fiável....para si há a FABARM ASPER. Produzida em colaboração com uma famosa empresa Alemã de Suhl, a ASPER é uma referência no que toca a precisão. O cano, resultado de mais de 100 anos de conhecimento acumulado, é fabricado por martelagem a frio e possui um sistema de montagens exclusivo. A bascula em aço forjado com gravuras em profundidade tem um elegante acabamento em nitrato de prata. Madeiras de luxo com acabamento a óleo. A ASPER PRESTIGE é fornecida com a mala ESTHETE™ adaptada, com espaço para a mira telescópica.

# ASPER PRESTIGE



ASPER PRESTIGE

NEW



ESTHETE™ EXPRESS



ASPER PRESTIGE	
CAUBERS	30.06 SPRG - 30R BLASER 8x57 JRS - 9,3 x 74R
	55 cm / 22"
EJECTORS	YES
	PISTOL WITH CHEEK PIECE
	367
WOOD FINISH	OILED
RECEIVER	FORGED STEEL
RECEIVER FINISH	SILVER NITRITE
CASE	• ESTHETE™
KG	3,25

**GB** The receiver, in forged steel has a fully titanium coating for total protection. The sights with fiber optic inserts are adjustable. The ASPER comes in an aluminum case.

**I** La bascula, in acciaio forgiato, è integralmente rivestita con protezione titanio. I mirini con inserti in fibra ottica sono regolabili. ASPER è fornito in valigetta di alluminio.

**F** La bascule, en acier forgé, a une protection intégrale de titane. Les organes de visée, avec fibre optique, sont réglables. L'ASPER est livrée en valise aluminium.

**E** La báscula en acero forjado esta totalmente revestida de titanio para su protección. Los puntos de mira en fibra óptica son regulables. El rifle ASPER se suministra con un estuche de aluminio.

**P** A báscula, em aço forjado, é totalmente revestida a titânio para protecção. Os pontos de mira em fibra óptica são reguláveis. A ASPER é fornecida numa mala de alumínio.

# ASPER





ASPER

Adjustable trigger for accurate shot.  
Grilletto regolabile per una migliore adattabilità allo sparo.  
Défente réglable pour un tir précis.  
Disparador ajustable para un disparo preciso.  
Gatilho regulável para um tiro mais preciso.



Specific scope mount system for a very low optical sight axis above the barrel.  
Sistema esclusivo montaggio ottica per garantire un ridotto ingombro tra canna e ottica.  
Montage spécifique garantissant une distance lunette/canon très réduite.  
Sistema exclusivo de miras, que permite una distancia mira-cañón muy reducida.  
Montagens específicas, permitem uma distância mira/cano muito reduzida.

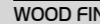

ASPER	
CALIBERS	30.06 SPRG - 30R BLASER 8x57 JRS - 9,3 x 74R
	55 cm / 22"
EJECTORS	YES
	PISTOL WITH CHEEK PIECE
	367
WOOD FINISH	TRIWOOD
RECEIVER	FORGED STEEL
RECEIVER FINISH	TITANIUM
CASE	• ALUMINIUM
KG	3,25



ALUMINIUM  
CASE

**G** When we started the NOBILE project years ago from a clean page, the briefing we made to our engineers was to invent a side by side and forget the past. They have done it!  
From the FABARM previous side by side generation we only maintain the 4 locks which avoid all lateral weakness. The NOBILE is a revolutionary shotgun oriented to the present and future.  
Its TRIBORE® HP barrel, 20M gauge, has the ultimate choke tubes generation- the INNER HP™ - 82 mm long. Its design and shape are modern, innovative, fluid.

**I** I tecnici FABARM hanno realizzato il progetto NOBILE partito alcuni anni fa dall'idea iniziale di superare certi schemi tradizionali delle doppiette, e così è avvenuto. Si è mantenuta la caratteristica peculiare delle doppiette FABARM riguardante i 4 ramponi che evitano le torsioni laterali.  
NOBILE è un fucile rivoluzionario che si orienta al presente ed al futuro.  
La canna TRIBORE® HP cal.20M prevede una serie di strozzatori dell'ultima generazione, gli INNER HP™ lunghi 82 mm. Il loro profilo è moderno, innovativo e fluido.

**F** Lorsque nous avons démarré le projet NOBILE d'une page blanche il y a quelques années, la demande faite à nos ingénieurs était d'inventer un fusil juxtaposé en faisant abstraction du passé. Et ils l'ont fait.  
De la précédente génération de fusils juxtaposés FABARM, nous avons simplement maintenu les 4 crochets qui évitent tout jeu latéral. Le NOBILE est un fusil révolutionnaire orienté vers le présent et le futur.  
Son canon TRIBORE® HP, calibre 20M, possède des chokes de dernière génération - les INNER HP™ - d'une longueur de 82 mm. Sa ligne est moderne, innovante, fluide.

**E** Cuando hace unos años iniciamos el proyecto NOBILE, lo hicimos desde cero, nuestros ingenieros solo tenían una consigna diseñar una escopeta paralela diferente al resto, y lo hicieron.  
De la antigua generación de paralelas FABARM sólo mantenemos el sistema de 4 cierres.  
El modelo NOBILE es una revolucionaria escopeta orientada al presente y al futuro. Su cañón TRIBORE® HP calibre 20M, incorpora la última generación de chokes intercambiables- los INNER HP™ - 82 mm largo.

**P** Quando o projecto NOBILE foi iniciado há uns anos, a partir de uma folha em branco, pedimos aos nossos engenheiros que inventassem uma arma de justapostos e que esquecessem o passado. E foi isso que eles fizeram. Da geração anterior de armas FABARM justapostos, apenas foram mantidos os 4 fechos de mesa, que evitam movimentos laterais. A NOBILE é uma arma revolucionária a pensar no presente e no futuro. O cano TRIBORE® HP calibre 20M, vem equipado com os chokes da última geração - os INNER HP™ - com 82mm de comprimento. Possui linhas modernas, inovadoras e fluidas.

NOBILE GRADE III	
GAUGE	20/3" (20/76)
	66/26" - 71/28" - 76/30"
CHOKES	INNER HP SHORT - MEDIUM - LONG - XTREME
RIB (mm)	7-4
	ENGLISH
	367
	FIELD
WOOD FINISH	OIL FINISH
RECEIVER FINISH	TITANIUM
	•ESTHETE™
KG	2,50 - 2,60

In option: INNER HP ULTIMATE - INNER HP PARADOX

# NOBILE GRADE III



100%  
ESTHETE™

ESTHETE™  
CASE



Ejection selector system: automatic ejection or manual extraction.  
Sistema di selezione ejector: estrazione automatica o manuale.  
Système sélectif de l'éjection: éjection automatique ou extraction manuelle.  
Sistema de expulsión, automáticos o manuales.  
Sistema selectivo de ejección. ejectores automáticos ou manuais.

Adjustable opening tension.  
Tiraggio cerniera regolabile.  
Charnière à résistance réglable.  
Sistema ajustable de apertura.  
Tensão de extracção regulável.

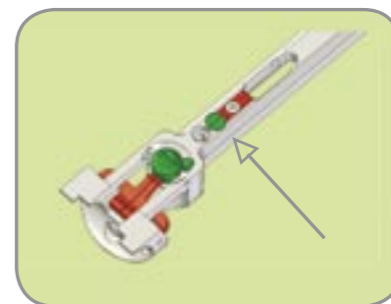

4 INNER HP™ (hyperbolic profile) 82 mm long.  
4 INNER HP™ (profilo iperbolico) 82 mm di lunghezza.  
4 INNER HP™ (profil hyperbolique) d'une longueur de 82 mm.  
4 INNER HP™ (perfil hiperbolico) largo de 82 mm.  
4 INNER HP™ (perfil hiperbólico) comprimento de 82 mm.

FABARM®





**GB** Classic, elegant, attractive... there are many adjectives to describe this NOBILE GRADE II. Its lightweight receiver has a very refined engraving associated with a nice stock, oil finished. The TRIBORE® HP barrel with the hyperbolic choke tubes (82 mm long), the adjustable opening system, the selector of ejection (automatic or manual) and its 4 locking lugs place the NOBILE as an extremely hi-tec and robust side by side shotgun.

**I** Classica, elegante, attraente... vi sono molti aggettivi adatti a descrivere la NOBILE GRADE II. La sua bascula è finemente incisa ed è accompagnata ad un calcio selezionato finito ad olio. La canna TRIBORE® HP con strozzatori a profilo iperbolico (lunghi 82 mm), la cerniera a tensione regolabile, il selettore dell'estrazione (automatica o manuale) e i suoi 4 ramponi fanno della NOBILE una doppietta estremamente solida e tecnologicamente avanzata.

**F** Classique, élégant, attractif... il y a beaucoup d'adjectifs possibles pour décrire ce NOBILE GRADE II. Sa bascule allégée a une superbe gravure associée à une jolie crosse en finition à l'huile. Le canon TRIBORE® HP avec ses chokes hyperboliques (d'une longueur de 82 mm), la charnière à résistance réglable, le sélecteur d'éjection (automatique ou manuelle) et ses 4 crochets placent le NOBILE comme un fusil juxtaposé extrêmement hi tec et robuste.

**E** Clásica, elegante, atractiva, hay muchos adjetivos para describir la nueva NOBILE GRADE II. Báscula ligera, elegantes grabados, preciosa madera acabada al aceite. Un hito en el desarrollo tecnológico de la escopeta paralela cañones TRIBORE HP con chokes hiperbolicos de 82 mm de largo, sistema ajustable de apertura, selector manual de expulsores (manual o automáticos), y con 4 enganches de cierre.

**P** Clássica, elegante, atractiva... há muitos adjetivos para descrever a NOBILE GRADE II. A sua bascula em liga leve suporta umas gravuras soberbas associadas a uma bonita coronha com acabamento a óleo. O cano TRIBORE® HP com os choques hiperbólicos (82mm comprimento), a tensão de abertura regulável, o sistema selectivo de ejeção - automático ou manual e os 4 fechos de mesa, fazem da NOBILE uma arma de canos justaposto extremamente robusta e hi-tec.

NOBILE GRADE II	
GAUGE	20/3" (20/76)
	66/26" - 71/28" - 76/30"
CHOKES	INNER HP SHORT - MEDIUM - LONG - XTREME
RIB (mm)	7-4
	ENGLISH
	367
	FIELD
WOOD FINISH	OIL FINISH
RECEIVER FINISH	TITANIUM
	INTEGRALE™
KG	2,50 - 2,60

In option: INNER HP ULTIMATE - INNER HP PARADOX

# NOBILE GRADE II



TRIBORE®  
HP

NEW

NOBILE GRADE II

100%  
extraction



4 separate lugs to avoid lateral weakness.  
4 ramponi separati per evitare le torsioni laterali.  
4 crochets pour éliminer tout jeu latéral.  
4 puntos de cierre separados para evitar la componente lateral.  
4 fechos de mesa, para eliminar movimientos laterais.



Ejection selector system: automatic ejection or manual extraction.  
Sistema di selezione ejector: estrazione automatica o manuale.  
Système sélectif de l'éjection: éjection automatique ou extraction manuelle.  
Sistema de expulsión, automáticos o manuales.  
Sistema selectivo de ejeção. ejectores automáticos ou manuais.



4 INNER HP™ (hyperbolic profile) 82 mm long.  
4 INNER HP™ (profilo iperbolico) 82 mm di lunghezza.  
4 INNER HP™ (profil hyperbolique) d'une longueur de 82 mm.  
4 INNER HP™ (perfil hiperbolico) largo de 82 mm.  
4 INNER HP™ (perfil hiperbólico) comprimento de 82 mm.



INTEGRALE™  
CASE

FABARM®



**GB** The BETA GRADE IV is made for those who are looking for a unique and prestigious side by side. The engraving is really refined with game scenes. With its wood recoil pad, its carefully selected walnut, the fine chequering on its english stock, the BETA GRADE IV is the work of master craftsmen. Of course it has our excellent receiver with four separate locking lugs. It comes in the ESTHETE™ gun case.

**I** La BETA GRADO IV é stata realizzata per tutti coloro che si rivolgono ad una doppietta unica e prestigiosa. L'incisione é veramente raffinata e con ricercati motivi di caccia. Grazie ai legni in noce accuratamente selezionata, al calciolo in legno, allo zigrino fine su calcio all'inglese, BETA GRADO IV rappresenta davvero il lavoro di maestri armaioli. BETA GRADO IV é fornita in valigetta ESTHETE™.

**F** Le BETA GRADE IV est fait pour ceux qui recherchent un fusil juxtaposé unique et prestigieux. La gravure à motifs animaliers est vraiment très raffinée. Avec sa plaque de couche en bois, le choix méticuleux du noyer, le quadrillage fin de sa crosse anglaise, le BETA GRADE IV est le travail de maitre artisans. Evidement il est réalisé à partir de notre excellente bascule à 4 crochets. Il est livré dans notre valise ESTHETE™.

**E** La modelo BETA GRADE IV esta fabricada para aquellos que buscan una escopeta pararela única y de prestigio. Grabados refinados con motivos de animales. Cantonera de madera, madera de nogal seleccionada, fina picadura en culata inglesa, la modelo BETA GRADE IV es la obra de un maestro armero. Y además nuestro sistema de cuatro enganches que le hacen una escopeta realmente robusta. Se suministra con estuche ESTHETE™.

**P** A BETA GRADE IV foi pensada para aqueles que procuram uma arma justapostos unica e de prestigio. As cenas de caça das gravuras, são realmente requintadas. A BETA GRADE IV é um verdadeiro trabalho de artesão, com o calço em madeira, as madeiras seleccionadas e o fino quadrilhado da coronha inglesa. É evidentemente, tem a nossa bascula de 4 fechos de mesa. É fornecida na mala ESTHETE™.

Stock with wood recoil pad.  
Calcio con calciolo in legno.  
Crosse avec plaque de couche bois.  
Culata con cantonera de madera.  
Coronha com calço em madeira.







For INNER barrel only



BETA GRADE IV

ESTHETE™  
CASE



BETA GRADE IV	
GAUGE	12/3" (12/76)
	66/26" - 71/28" - 76/30"
CHOKES	INNERCHOKES (S) OR 1/4 - 3/4 (IC/IM)
RIB (mm)	10-7
	ENGLISH
	365
	FIELD
WOOD FINISH	EXTRA LUX OILED
RECEIVER FINISH	TENIFER
	• ESTHETE
KG	3,00 - 3,25

Fine checkering and oil finish.  
Zigrinatura fine e finitura ad olio.  
Quadrillage fin et poncé à l'huile.  
Fina picadura y acabado al aceite.  
Quadrilhados finos e acabamento a óleo.



Arabesques and animal motifs.  
Fine incisione con motivi di caccia.  
Arabesques et motifs animaliers.  
Arabescos y motivos de animales.  
Motivos de caça e arabescos.



**GB** Lightweight, rounded receiver profile made in forged steel, delicate deep engraving on a silver nitrite, the CLASSIS 20 offers beauty with functions. TRIBORE® HP barrel with INNER HP™ 82 mm long. The English stock oil finished, the slim-style forend and low profile top rib bring the target into perfect alignment. Built with 4 locking lugs for unlimited years of shooting.

**I** Bascula leggera dal profilo arrotondato in acciaio forgiato, delicata incisione e finitura argento vecchio, la CLASSIS 20 unisce bellezza e performances. Canna TRIBORE® HP con INNER HP™ lunghi 82 mm. Il calcio inglese finito ad olio, l'astina sottile e la bindella ribassata garantiscono un'acquisizione perfetta del bersaglio. La chiusura è a 4 ramponi per un uso illimitato.

**F** Léger, bascule au profil arrondi en acier forgé, délicate gravure profonde avec une finition vieil argent, le CLASSIS 20 offre beauté et performances. Canon TRIBORE® HP avec choke INNER HP™ d'une longueur de 82 mm. La crosse anglaise finie à l'huile, le garde main affiné et la bande de visée rabaissée sont le garant d'une prise de visée parfaite. Mécanisme avec 4 crochets pour une utilisation sans limite.

**E** Ligera, báscula redondeada de careo forjado, elegantes grabados. El modelo CLASSIS 20 ofrece belleza con funcionalidad. Cañones TRIBORE con chokes INNER HP de 82 mm. Culata inglesa acabada al aceite. Elegante guardamanos y una lista de bajo perfil que permite encarar de forma perfecta. Cuatro enganches que dan una robustez insuperable a la escopeta.

**P** Leve, báscula com perfil arredondado em aço forjado, gravuras delicadamente gravadas em profundidade em nitrito de prata, a CLASSIS 20 oferece beleza com funcionalidade. Cano TRIBORE® HP com chokes INNER HP™ (82mm comprimento). A coronha inglesa com acabamento a óleo, o fuste com estilo estreito e a fita de mira rebaixada são o garante de um encare perfeito. Construída com 4 fechos de mesa para uma utilização sem limites.

# CLASSIS 20



CLASSIS 20

INTEGRALE™  
CASE



4 INNER HP™ (hyperbolic profile) 82 mm long.  
4 INNER HP™ (profilo iperbolico) 82 mm di lunghezza.  
4 INNER HP™ (profil hyperbolique) d'une longueur de 82 mm.  
4 INNER HP™ (perfil hiperbólico) largo de 82 mm.  
4 INNER HP™ (perfil hiperbólico) comprimento de 82 mm.



4 separate lugs to avoid lateral weakness.  
4 ramponi separati per evitare le torsioni laterali.  
4 crochets pour éliminer tout jeu latéral.  
4 puntos de cierre separados para evitar la componente lateral.  
4 fechos de mesa, para eliminar movimientos laterais.

CLASSIS 20	
GAUGE	20-3" (20/76)
	66/26" - 71/28" - 76/30"
CHOKES	INNER HP (4) SHORT - MEDIUM - LONG - XTREME
RIB (mm)	7-4
	ENGLISH
	365
	FIELD
WOOD FINISH	OILED
FRAME FINISH	TENIFER
	• INTEGRALE™
KG	2,70 - 2,85

In option : INNER HP ULTIMATE - INNER HP PARADOX

FABARM®

**GB** The BETA CLASSIS shotgun uses four separate lugs. The round body receiver is made with forged steel. The balance, the weight are carefully studied with its lightweight barrel combined with the stock configuration. A very refine engraving, selected wood with oil finish and wooden recoil pad.

**I** La BETA CLASSIS ha 4 ramponi indipendenti. La bascula costruita in acciaio forgiato è elegantemente arrotondata. Il peso è contenuto e la leggerezza delle canne è stata studiata in modo da ottenere una perfetta combinazione tra peso ed eleganza dell'arma, grazie anche al design dei legni. Incisione fine e raffinata, legni selezionati in noce con calciolo in legno, finiti ad olio.

**F** Le fusil BETA CLASSIS possède 4 crochets. La bascule, au profil arrondi, est réalisée en acier forgé. L'équilibre, le poids ont été précisément étudiés avec un canon allégé et la configuration de la crosse. Très élégance gravure, des bois sélectionnés et une plaque de couche en noyer.

**E** El modelo BETA CLASSIC tiene cuatro enganches, la bascula redonda es de acero forjado. El balance, el peso, la configuración de la culata están perfectamente estudiados. Fino grabado, madera seleccionada con acabado al aceite y cantonera de madera.

**P** A arma BETA CLASSIS tem quatro fechos de mesa. A bascula com perfil arredondado é feita em aço forjado. Equilíbrio e peso cuidadosamente estudados, combinando a leveza dos canos com a configuração da coronha. Gravuras refinadas, madeiras altamente seleccionadas com acabamento a óleo e calço em madeira.

# CLASSIS 12





CIP  
STEEL SHOT

**CLASSIS 12 ENGLISH**  
(CONFIGURATION: FIELD)



CIP  
STEEL SHOT

**CLASSIS 12 PISTOL**  
(CONFIGURATION: SEMI-BEAVERTAIL)

	<b>CLASSIS 12</b>	<b>CLASSIS 12</b>
GAUGE	12-3" (12/76)	12-3" (12/76)
	61/24" PARADOX	66/26" - 71/28" - 76/30"
CHOKES	PARADOX/M (1/2)	INNERCHOKES (5)
RIB (mm)	10-7	10-7
	ENGLISH OR PISTOL	ENGLISH OR PISTOL
	365	365
	FIELD OR SEMI-BEAVERTAIL	FIELD OR SEMI-BEAVERTAIL
WOOD FINISH	OILED	OILED
FRAME FINISH	TENIFER	TENIFER
	•INTEGRALE™	•INTEGRALE™
KG	2,80	2,9 - 3,15

## 2 CONFIGURATIONS:



FIELD



SEMI-BEAVERTAIL



The sense of detail and elegance.  
La cura nei particolari e la ricerca dell'eleganza.  
Le sens du détail et de l'élégance.  
El sentido del detalle y la elegancia.  
Um detalhe de elegância.



4 separate lugs to avoid lateral weakness.  
4 ramponi separati per evitare le torsioni laterali.  
4 crochets pour éliminer tout jeu latéral.  
4 puntos de cierre separados para evitar la componente lateral.  
4 fechos de mesa, para eliminar movimientos laterais.



The tubes are silver soldered and internally hard chromed.  
Le canne sono saldate in lega d'argento e cromate internamente.  
Les canons sont soudés à l'argent. L'intérieur est chromé.  
Los cañones están soldados con aleación de plata, cromados interiormente.  
Os canos são soldados com solda de prata. O interior é cromado.

**GB** A technology concentrate... With its TRIBORE® HP barrel gauge and the INNER HP™ removable choke tubes, the AXIS will be the standard by which all other guns will be judged. The INNER HP™ are the first removable choke tubes with an hyperbolic profile. Innovations also with the AXIS general shape, the coatings made with titanium, zirconium, its sense of perfect ergonomomy and confort. With its forged steel receiver, it will be just perfect for parcours or hunting.

**I** Un concentrato di tecnologia... Con la sua canna TRIBORE® HP e gli strozzatori INNER HP™ AXIS sarà il punto di riferimento del domani. Gli strozzatori INNER HP™ sono i primi realizzati con un lungo profilo interno iperbolico. Novità per l'AXIS nella linea estetica, nei trattamenti titanio e zirconio, nella ergonomia e confort perfetti. Con la sua bascula in acciaio forgiato, sarà semplicemente ideale per il percorso e la caccia.

**F** Un concentré de technologie... Avec son canon TRIBORE® HP et les chokes interchangeables INNER HP™, L'AXIS sera demain la nouvelle référence en terme d'efficacité. Les INNER HP™ sont les premiers chokes amovibles ayant un profil hyperbolique. Innovations également avec la ligne générale de l'AXIS, les traitements titane, zirconium, son ergonomie et confort. Avec sa bascule en acier forgé, il sera simplement idéal pour le parcours et la chasse.

**E** Tecnología concentrada. Con su cañón TRIBORE® HP y los chokes intercambiables INNER HP™, AXIS será referencia de eficacia el día de mañana. Los chokes intercambiables INNER HP™ son los primeros chokes intercambiables con un perfil hiperbólico. El diseño de AXIS también es novedoso, recubierto con titanio zirconio, su sentido de la perfecta ergonomía y comodidad. Báscula de acero forjado, perfecta para la caza.

**P** Um concentrado de tecnologia... com o cano TRIBORE® HP e os chokes intercambiáveis INNER HP™, a AXIS será a futura referência de eficácia. Os INNER HP™ são os primeiros chokes intercambiáveis com um perfil hiperbólico. A inovação continua com as linhas da AXIS, os acabamentos em titânio, zircônio, a ergonomia e o conforto. A bascula em aço forjado, tomam-na ideal para o percurso de caça e para a caça.

# AXIS FIELD 20-28



TRIBORE®  
HP



NEW

AXIS FIELD 28 (OILED)

TRIBORE®  
HP

AXIS FIELD 20M (TRIWOOD)

TITANIUM  
100%  
PROTECTOR

TITANIUM  
100%  
PROTECTOR

INTEGRALE™  
CASE

	AXIS FIELD 20/3" (20/76)	AXIS FIELD 28/2 3/4" (28/70)
GAUGE	20/3" (20/76)	28/2 3/4" (28/70)
	61/24"-66/26"-71/28"-76/30"	71/28"
CHOKES	INNER HP (4) SHORT - MEDIUM - LONG - XTREME	INNER HP (4) SHORT - MEDIUM - LONG - XTREME
RIB (mm)	7-5	7-5
	PISTOL	PISTOL
	367	367
	FIELD	FIELD
WOOD FINISH	OILED OR TRIWOOD	OILED OR TRIWOOD
RECEIVER FINISH	TITANIUM	TITANIUM
	• INTEGRALE™	• INTEGRALE™
KG	2,75 - 2,90	2,80 - 2,90

In option on 20 Gauge: INNER HP ULTIMATE - INNER HP PARADOX



4 INNER HP™ (hyperbolic profile).  
4 INNER HP™ (profilo iperbolico).  
4 INNER HP™ (profil hyperbolique).  
4 INNER HP™ (perfil hiperbólico).  
4 INNER HP™ (perfil hiperbolico).

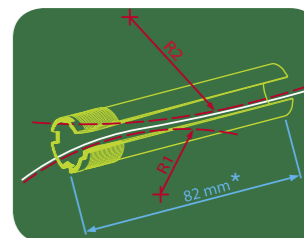

Profile ideal for steel shot uses.  
Profilo ideale per pallini acciaio.  
Profil idéal pour le tir de grenaille d'acier.  
Perfil ideal para el uso del cartucho de acero.  
Perfil ideal para o tiro com esferas de aço.



An adjustable trigger for 6 positions.  
Grilletto regolabile in 6 posizioni.  
Une détente réglable à 6 positions.  
Disparador ajustable de 6 posições.  
Disparador ajustable en 6 posiciones.

FABARM®

**GB** The lightweight version of the AXIS. With its very fluid and modern shape, its perfect balance, the AXIS AL is perfectly designed for hunting. The TRIBORE® HP and its hyperbolic choke tubes that gives unequalled results in terms of distribution and penetration. No compromise on comfort, thanks to the interchangeable recoil pad and a perfect shotgun ergonomomy.

**I** La versione leggera di AXIS. La sua linea é molto sobria, moderna e perfettamente bilanciata. AXIS rappresenta il massimo dell'efficienza per la caccia. La canna TRIBORE® HP e i suoi lunghi strozzatori a profilo iperbolico forniscono risultati ineguagliabili per quanto riguarda la penetrazione e la distribuzione dei pallini. Confortevole allo sparo grazie al calciolo molto soffice ed ad una perfetta ergonomia.

**F** La version light de l'AXIS. Avec sa ligne fluide, moderne et son équilibre parfait, l'AXIS AL est vraiment optimal pour la chasse. Le canon TRIBORE® HP et ses chokes hyperboliques donnent des résultats sans équivalence en matière de groupement et de pénétration. Aucun compromis sur le confort, grâce à la plaque de couche interchangeable et à la parfaite ergonomie de l'arme.

**E** AXIS AL es la versión ligera del modelo AXIS. Con un diseño moderno y un balance perfecto la escopeta AXIS AL es realmente efectiva para la caza. El cañón TRIBORE® HP y sus chokes hiperbólicos dan resultados inigualables en términos de plomeo y penetración. Gracias a su cantonera intercambiable y a su perfecta ergonomía el confort esta asegurado.

**P** Versão ligeira da AXIS. As suas linhas fluidas, modernas e um equilíbrio perfeito, tornam-na perfeita para a caça. O cano TRIBORE® HP e os chokes hiperbólicos obtêm resultados sem comparação, em termos de agrupamento e penetração. Sem compromissos ao nível do conforto graças ao calço inter-cambiável e à ergonomia perfeita da arma.



Modern top rib and optic fiber front sight. Bindella moderna e mirino in fibra ottica. Bande moderne et guidon fibre optique. Lista de diseño moderno y punto de mira de fibra óptica. Fita moderna e ponto de mira em fibra optica.

# AXIS AL 20-28



100% protection



AXIS AL 20M (OILED)

100% protection



AXIS AL 28 (TRIWOOD)



INTEGRALE™ CASE



4 INNER HP™ (hyperbolic profile).  
4 INNER HP™ (profilo iperbolico).  
4 INNER HP™ (profil hyperbolique).  
4 INNER HP™ (perfil hiperbólico).  
4 INNER HP™ (perfil hiperbolico).



Perfect ergonomoy. Perfetta ergonomia. Ergonomie parfaite. Ergonomia perfecta. Ergonomia perfeita.

	AXIS AL	AXIS AL
GAUGE	20/3" (20/76)	28/2 3/4" (28/70)
CHOKES	61/24" - 66/26" - 71/28" - 76/30"	71/28"
RIB (mm)	7-5	7-5
WOOD FINISH	OILED OR TRIWOOD	OILED OR TRIWOOD
RECEIVER FINISH	TITANIUM	TITANIUM
KG	2,55 - 2,70	2,65

In option on 20 Gauge: INNER HP ULTIMATE - INNER HP PARADOX



HUNTING

## TRIBORE HP®

Deep drilling process to manufacture all the tubes.  
 Foratura del pieno per tutti i tubi.  
 Tous les tubes produits par forage de barres pleines.  
 Todos los cañones son producidos a partir de barra maciza taladrada.  
 Todos os canos são produzidos de um varão maciço pelo processo de brocagem.

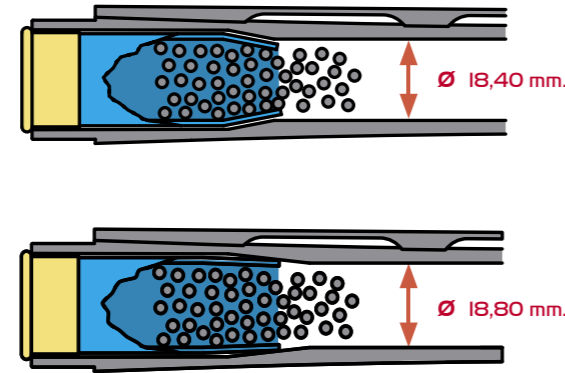
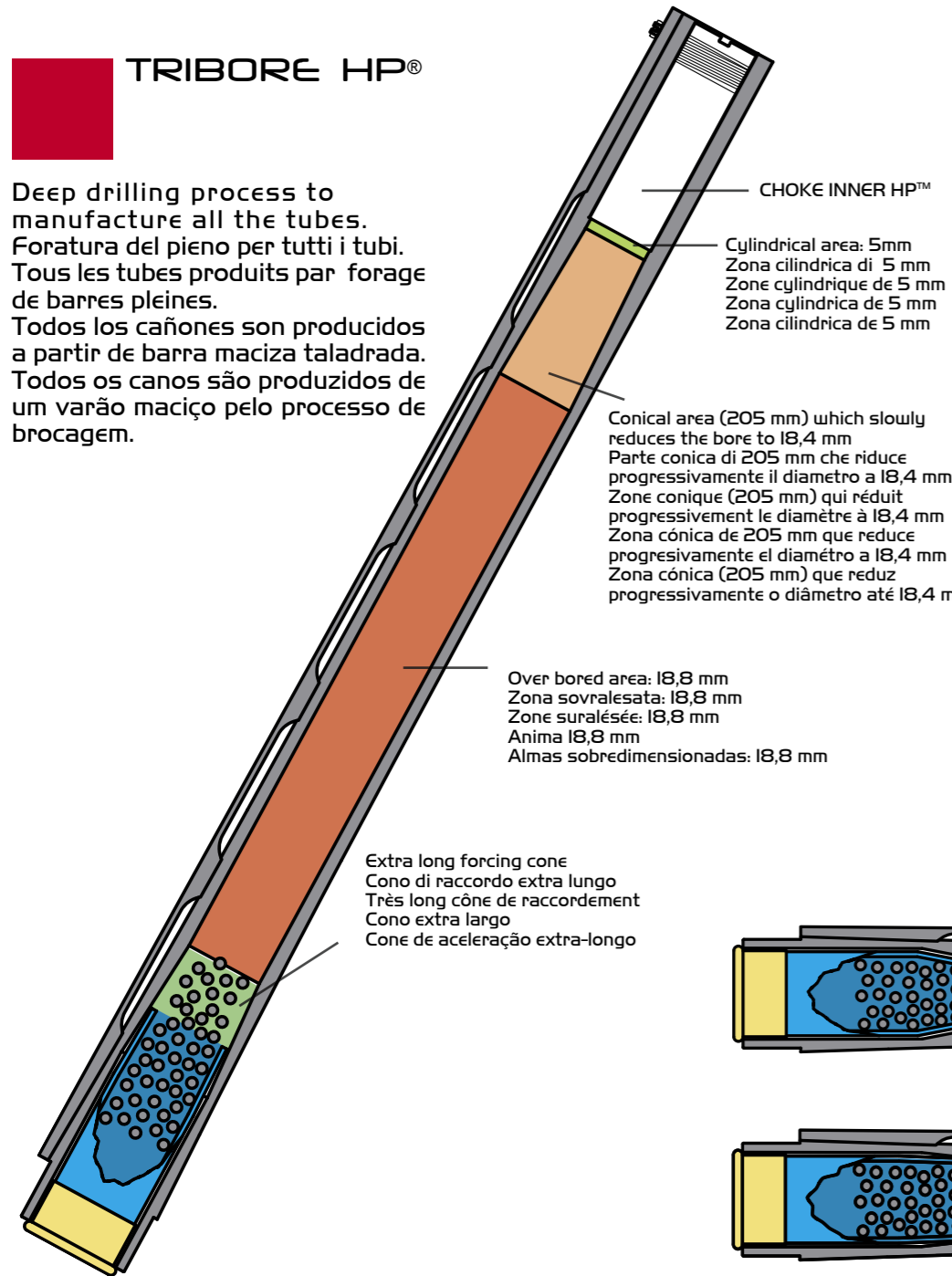

## INNER HP™

**PATENTED**



## 12 GAUGE

Set of 4 INNER HP™ (short – medium – long – xtreme) for all distances shots.  
 Set di 4 INNER HP™ (corto-medio-lungo-estremo) per tutte le distanze di tiro.  
 Set de 4 INNER HP™ (short – medium – long – xtreme) pour toutes les distances de tir.  
 Juego de 4 INNER HP™ (corto – medio – largo – xtreme) para todas las distancias de tiro.  
 Conjunto de 4 INNER HP™ (curto – médio – longo – xtreme) para todas as distâncias.



TRIBORE

## FABARM INNER HP™

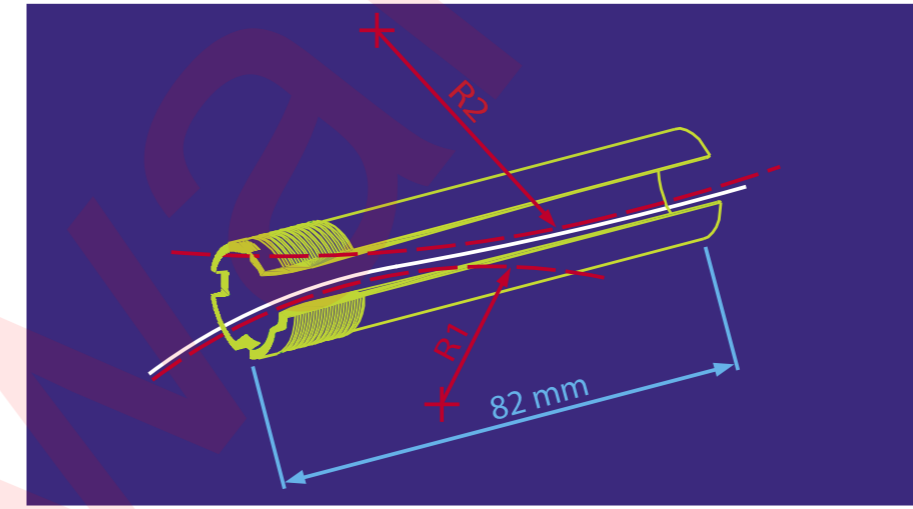

- An hyperbolic design for less compressive stress on the pellets.
- Un profilo interno iperbolico per ridurre lo stress di schiacciamento dei pallini.
- Design hyperbolique pour réduire les contraintes de compression de la gerbe.
- Diseño hiperbólico que ayuda a reducir las presiones que soportan los perdigones.
- Design hiperbólico reduz a força de compressão nos chumbos.

## FABARM INNER HP™



## COMPETITORS



## COMPETITORS

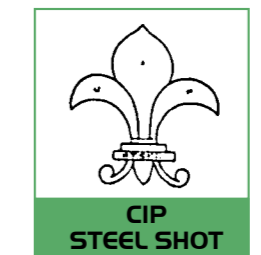
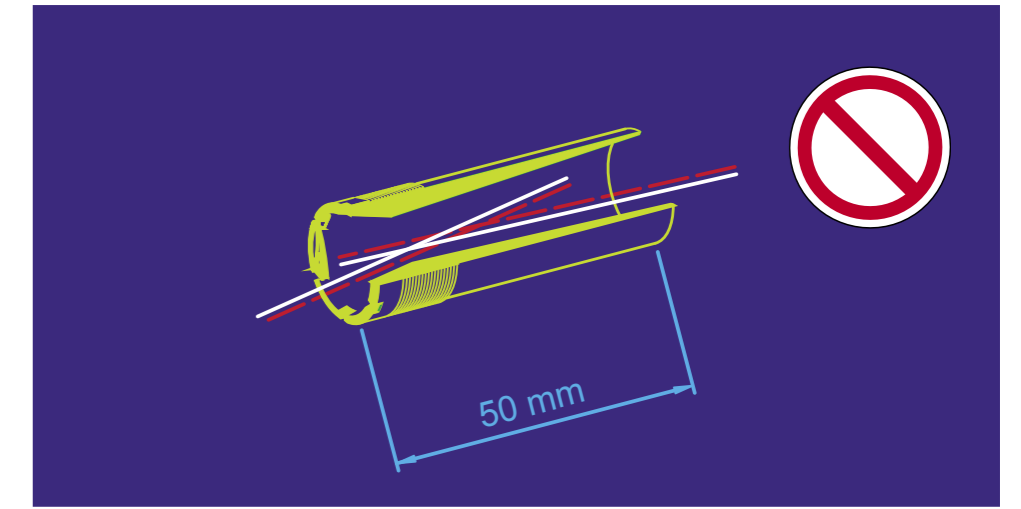

UNIQUE: Steel shot high performances can be used perfectly in all INNER HP™, even in the LONG (7/10) and XTREME (9/10) ones.  
 ESCLUSIVO: Cartucce pallini in acciaio "high performances" possono essere utilizzate con tutti gli INNER HP™, anche LONG (7/10) ed XTREME (9/10).  
 EXCLUSIF: Les munitions billes d'acier « hautes performances » peuvent être parfaitement utilisées dans tous les INNER HP™, y compris le LONG (7/10) et XTREME (9/10).  
 UNICO: Todos los choques INNER HP™ permiten usar cartuchos de perdigón de acero, incluso LARGO (7/10) y el XTREME (9/10).  
 EXCLUSIVO: Todos os canos INNER HP™ permitem o uso de cartuchos com chumbo de aço «alto desempenho», mesmo com os chokes LONG (7/10) e XTREME (9/10).



The TRIBORE® HP barrel surpasses all other barrels: better penetration, better distribution, best choke system for steel shot... it pushes the limits of ballistic.

La canna TRIBORE® HP é superiore a tutte le altre per la maggiore penetrazione e distribuzione dei pallini, la migliore tipologia di strozzatura per pallini in acciaio... oltre il limite balistico.

Le canon TRIBORE® HP surpasse tous les autres canons: meilleure pénétration, meilleur groupement, meilleur choke pour le tir de grenaille d'acier... il repousse les limites de la ballistique.

El canon TRIBORE® HP supera todos los cañones. Mejor penetración, mejor plomeo, mejor sistema de chokes para cartuchos de acero... supera todos los límites de la balística.

O cano TRIBORE® HP supera todos os outros: melhor penetração, melhor dispersão, melhor choke para tiro com esferas de aço... força os limites da balística.

## DISTRIBUTION

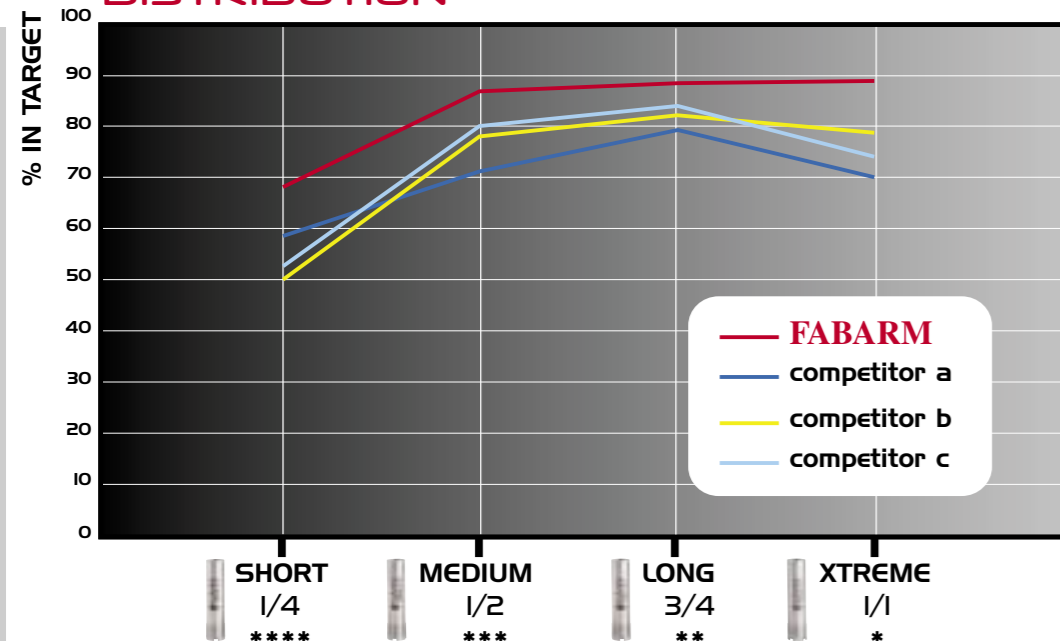

Distance 30 m

ø 75 cm.

35 g  
cal 12  
N° 4 STEEL  
(220 shots)

## TRIBORE HP BARREL

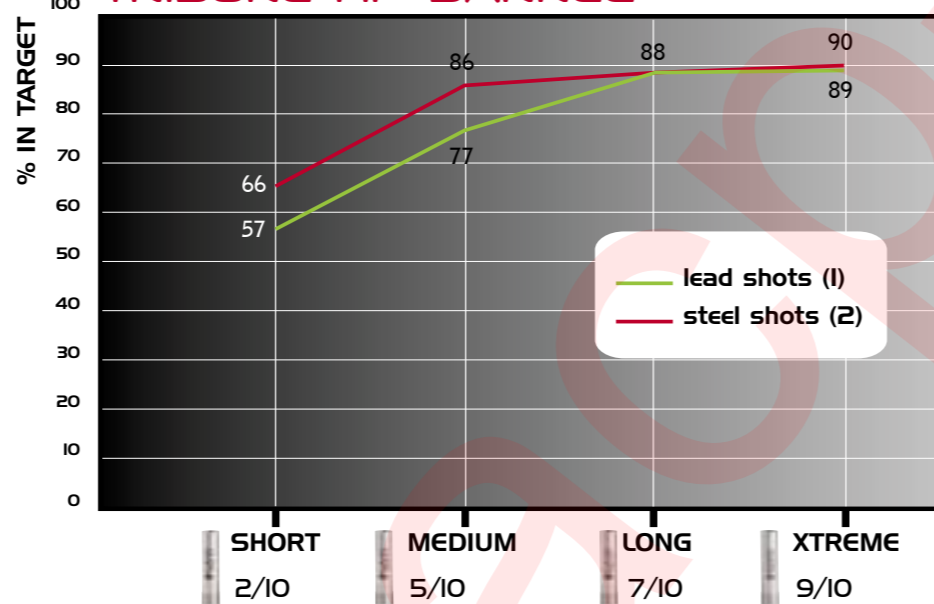

Distance 30 m

ø 75 cm.

(1)  
36 g  
cal 12  
N° 4 LEAD

(2)  
35 g  
cal 12  
N° 4 STEEL

**INDESTRUCTIBLE RECEIVER.  
BASCULA INDISTRUTTIBILE.  
BASCULE INDESTRUCTIBLE.  
BASCULA INDESTRUCTIBLE.  
BÁSCULA INDESTRUTÍVEL.**

AXIS AL :

ERGal 55 ( lightweight )  
ERGal 55 ( lega leggera )  
ERGal 55 ( allégée )  
ERGal 55 ( ligero )  
ERGal 55 ( liga leve )

AXIS FIELD :

Forged steel  
Acciaio forgiato  
Acier forgé  
Acero forjado  
Aço forjado



Interchangeable hinge pins.  
Perni intercambiabili.  
Tourillons interchangeables.  
Pasadores intercambiables.  
Pinos intercambiáveis.

**THE BEST LOCKING SYSTEM.  
LA MIGLIORE CHIUSURA.  
LE MEILLEUR VERROUILLAGE.  
EL MEJOR SISTEMA DE ENGANCHE.  
O MELHOR SISTEMA DE FECHO.**



AXIS utilizes a full width ( 29,70 mm ) flat locking bolt.  
AXIS dispone di un tassello basso (29,70 mm) su tutta la larghezza della bascula.  
AXIS possède a verrou plat ( 29,70 mm ) sur toute la largeur de la bascule.  
AXIS usa una pieza de cierre deslizante de 29,70 mm sobre toda la báscula.  
AXIS dispõe de um sistema de fecharia (29,70mm) a toda a largura da báscula.

**ADJUSTABLE OPENING TENSION.  
TIRAGGIO CERNIERA REGOLABILE.  
CHARNIÈRE À RÉSTANCE RÉGLABLE.  
SISTEMA AJUSTABLE DE APERTURA.  
TENSÃO DE EXTRACÇÃO REGULÁVEL.**

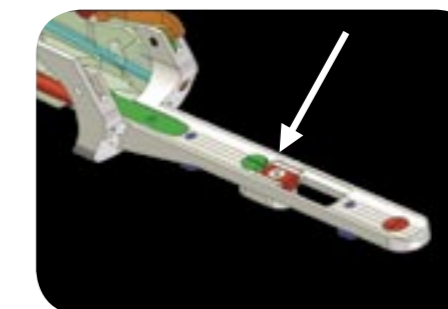

**GB** A revolutionary shotgun, an innovative design, exceptional distribution with hyperbolic choke tubes 82 mm long... The worldwide references are changing! Complete new hammer trigger system, new ejection mechanism, TRIBORE® HP barrel, adjustable opening tension, adjustable trigger for 6 positions, ergonomics perfectly studied. A tremendous feat of engineering realized with style and sense of aestheticism.

**I** Un fucile rivoluzionario con un design innovativo ed un'eccezionale distribuzione e penetrazione, grazie agli strozzatori iperbolici da 82 mm di lunghezza... stanno cambiando i punti di riferimento internazionali. Meccanica con nuovo gruppo di scatto e di estrazione automatica, canne TRIBORE® HP, regolazione del tiraggio della cerniera, grilletto regolabile in 6 posizioni, ergonomia generale studiata nei minimi particolari. Un incredibile connubio tra tecnologia ed estetica.

**F** Un fusil révolutionnaire, un design innovant, des groupements exceptionnels avec les chokes hyperboliques de 82 mm... les références mondiales changent! Complet nouveau système d'armement, nouveau mécanisme d'éjection, canon TRIBORE® HP, charnière à résistance réglable, détente réglable à 6 positions, ergonomie parfaitement étudiée. Une véritable prouesse technique réalisée avec style et sens de l'esthétique.

**E** Un arma revolucionaria, diseño innovador, excepcional plomeo con un choque hiperbólico de 82 cm. Las referencias mundiales están cambiando. Nuevo sistema de disparador, nuevo sistema de expulsión, cañón TRIBORE® HP, sistema de apertura ajustable, disparador ajustable en 6 posiciones. Una escopeta ergonómica, un tremendo esfuerzo de ingeniería mecánica aplicado con un sentido de la estética.

**P** Uma arma revolucionária, designe inovador, distribuição de tiro excepcional com os chokes INNER HP™ de perfil hiperbólico e 82mm de comprimento... As referências mundiais estão a mudar! Com um sistema de armar completamente novo, novo mecanismo de ejeção, canos TRIBORE® HP, tensão de abertura regulável, gatilho regulável de 6 posições, ergonomia perfeitamente estudada. Um tremendo feito de engenharia conseguido com estilo e profundo sentido de estética.

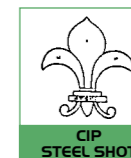

# AXIS FIELD 12



TRIBORE®  
HP

NEW

AXIS FIELD 12M (OILED)

TRIBORE®  
HP

AXIS FIELD 12M (TRIWOOD)

100%  
TITANIUM  
ANTI-CORROSION

100%  
TITANIUM  
ANTI-CORROSION

TriWood  
Excellence

INTEGRALE™  
CASE



4 INNER HP™ (hyperbolic profile) 82 mm long.  
4 INNER HP™ (profilo iperbolico) 82 mm di lunghezza.  
4 INNER HP™ (profil hyperbolique) d'une longueur de 82 mm.  
4 INNER HP™ (perfil hiperbolico) largo de 82 mm.  
4 INNER HP™ (perfil hiperbolico) comprimento de 82 mm.



Perfect ergonomics.  
Perfetta ergonomia.  
Ergonomie parfaite.  
Ergonomia perfecta.  
Ergonomia perfeita.

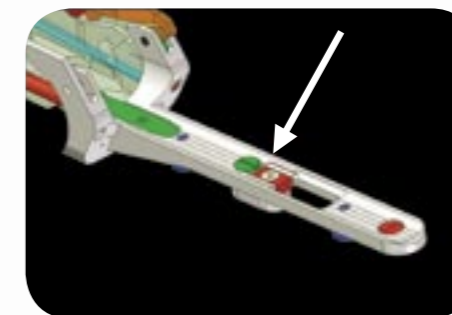

Adjustable opening tension.  
Tiraggio cerniera regolabile.  
Charnière à résistance réglable.  
Sistema ajustable de apertura.  
Tensão de extração regulável.

AXIS FIELD	
GAUGE	12/3" (12/76)
	66/26"-71/28"-76/30"
CHOKES	INNER HP (4) SHORT - MEDIUM - LONG - XTREME
RIB (mm)	7
	PISTOL
	367
	FIELD
WOOD FINISH	OILED OR TRIWOOD
RECEIVER FINISH	TITANIUM
	• INTEGRALE™
KG	2,90 - 3,15

In option: INNER HP ULTIMATE - INNER HP PARADOX



**GB** All the AXIS features and benefits...in a lightweight version. The receiver is made in Ergal 55. Perfect weight and balance, hyperbolic choke tubes, modern shape ... for a hunting shotgun without competitor.

**I** Tutte le caratteristiche ed i vantaggi di AXIS...in una versione leggera. La bascula è realizzata in Ergal 55. Peso e bilanciatura perfetti, strozzatori iperbolicici, legni eleganti e moderni... per un fucile da caccia che non ha concorrenti.

**F** Tous les caractéristiques et avantages de l'AXIS...dans une version allégée. La bascule est réalisée en Ergal 55. Poids et équilibre parfaits, chokes hyperboliques, ligne moderne... pour un fusil de chasse sans concurrent.

**E** Todos los beneficios y características del modelo AXIS pero en versión ligera. La báscula esta fabricada con ERGAL 55. Perfecto balance y peso, chokes hiperbolicos, diseño moderno... una escopeta de caza sin competencia.

**P** Todas as características e vantagens da AXIS... numa versão leve. A bascula é em Ergal 55. Peso e equilíbrio perfeitos, chokes hiperbólicos, linhas modernas... para uma arma de caça sem concorrência.

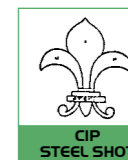

# AXIS AL 12



100%  
TITANIUM  
EXCELLENCE





100%  
TITANIUM  
EXCELLENCE

TriWood  
Excellence

INTEGRALE™  
CASE

4 INNER HP™ (hyperbolic profile) 82 mm long.  
4 INNER HP™ (profilo iperbolico) 82 mm di lunghezza.  
4 INNER HP™ (profil hyperbolique) d'une longueur de 82 mm.  
4 INNER HP™ (perfil hiperbolico) largo de 82 mm.  
4 INNER HP™ (perfil hiperbolico) comprimento de 82 mm.



AXIS AL	
GAUGE	12/3" (12/76)
	61/24"-66/26"-71/28"-76/30"
CHOKES	INNER HP (4) SHORT - MEDIUM - LONG - XTREME
RIB (mm)	7
	PISTOL
	367
	FIELD
WOOD FINISH	OILED OR TRIWOOD
RECEIVER FINISH	TITANIUM
	• INTEGRALE™
KG	2,65 - 2,85

In option: INNER HP ULTIMATE - INNER HP PARADOX

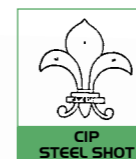

TRIBORE  
HP

NEW

AXIS AL 12M (OILED)

TRIBORE  
HP

AXIS AL 12M (TRIWOOD)



An adjustable trigger for 6 positions.  
Grilletto regolabile in 6 posizioni.  
Une détente réglable à 6 positions.  
Gatilho regulável de 6 posições.  
Disparador ajustable en 6 posiciones.

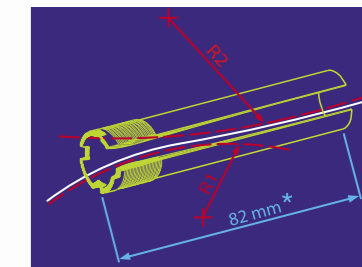

Ideal profile for steel shot uses.  
Profilo ideale per pallini acciaio.  
Profil idéal pour le tir de grenaille d'acier.  
Perfil ideal para el uso del cartucho de acero.  
Perfil ideal para o tiro com esferas de aço.

**GB** The GAMMA 2 FIELD receiver is made in forged steel and in ERGAL 55 for the GAMMA 2 AL. With its refine engraving, the 100% titanium coating of the top lever, the trigger guard and the forend bracket, our exclusive TRIWOOD finish, the GAMMA 2 has sophisticated and harmonious features.

**I** Il GAMMA 2 FIELD prevede una bascula in acciaio forgiato nella versione FIELD o in ERGAL 55 nella versione AL. Con la sua incisione raffinata, la protezione 100% Titanio sulla chiave di apertura, guardamano e croce e con l'esclusiva finitura TRIWOOD dei legni, il GAMMA 2 si presenta con caratteristiche sofisticate ed armoniose.

**F** La bascule du GAMMA 2 FIELD est en acier forgé et en ERGAL 55 pour le GAMMA 2 AL. Avec sa gravure très raffinée, la protection 100% titane de la clef, du pontet et du crochet, notre finition exclusive TRIWOOD, le GAMMA 2 a des caractéristiques sophistiquées et harmonieuses.

**E** La báscula del modelo GAMMA 2 FIELD esta fabricado de acero forjado y en el modelo GAMMA 2 AL es de ERGAL 55. Con un fino grabado, protección de titanio al 100% de la palanquilla de apertura, disparador y tecla de delantera. Con un acabado de la culata TRIWOOD, el modelo GAMMA 2 es una escopeta sofisticada y moderna.

**P** A báscula da GAMMA 2 FIELD é em aço forjado e em ERGAL 55 no modelo GAMMA 2 AL. Com gravuras requintadas, protecção 100% titânio na alavanca de abertura/fecho, no guarda-mato, fecharia do fuste, o nosso exclusivo acabamento TRIWOOD, a GAMMA 2 tem características sofisticadas e harmoniosas.



Adjustable trigger for 6 positions.  
Grilletto regolabile in 6 posizioni.  
Détoné réglable à 6 positions.  
Gatillo ajustable en 6 posiciones.  
Gatilho ajustável em 6 posições.

# GAMMA 2



GAMMA 2 FIELD

GAMMA 2 AL

CASE



A TRIWOOD finish for a better look and better protection.  
Finitura TRIWOOD: legni ancor più belli e meglio protetti dalle intemperie.  
Finition TRIWOOD: protection maximale, esthétique sans égal.  
Acabado TRIWOOD: maxima protección y estética sin igual.  
Acabamento TRIWOOD: imagem e protecção superiores.

	GAMMA 2 FIELD	GAMMA 2 AL	GAMMA 2 AL PARADOX
GAUGE	12-3" (12/76)	12-3" (12/76)	12-3" (12/76)
	66/26" - 71/28"	61/24" - 66/26" - 71/28"	61/24"
CHOKES	INNERCHOKES (5) C - IC - M - IM - F	INNERCHOKES (5) C - IC - M - IM - F	PARADOX - INNERCHOKES (3) C - IC - IM
RIB (mm)	7	7	7 SPECIFIC
	PISTOL OR ENGLISH	PISTOL OR ENGLISH	PISTOL OR ENGLISH
	367	367	367
	TULIP	TULIP	TULIP
WOOD FINISH	TRIWOOD	TRIWOOD	TRIWOOD
RECEIVER	FORGED STEEL	ERGAL 55	ERGAL 55
RECEIVER FINISH	TENIFER OR TRIKOLOR (3T)	GREY PEARL	GREY PEARL
	2,95 - 3,05	2,65 - 2,80	2,65



J  
N  
I  
T  
N  
U  
H

# WATERFOWL-ALPHA



WATERFOWL MAX 4 CAMO



ALPHA FIELD



A soft and interchangeable recoil pad. Un soffice calciolo intercambiabile. Plaque de couche très absorbante et interchangeable. Cantonera de goma intercambiabile. Calço anti-recuo e inter-cambiável.

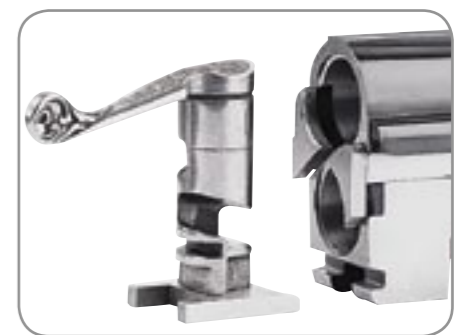

Highly durable locking lug. Una chiusura molto solida. Un verrouillage à toute épreuve. Maneta de cierre de gran durabilidad. Fecharias de elevada durabilidade, a toda a prova.



GB



**WATERFOWL**  
An ideal shotgun for waterfowl hunting. With its 12 Ga 3,5" (12/89 mm) chamber and its forged steel receiver, it can shoot very heavy load. The WATERFOWL 12M 3" (12/76) chamber is with automatic ejectors and is a perfect all-terrain shotgun. All shotguns are delivered with 5 INNERCHOKES plus 2 barrel extension 50 mm (2").

I

**WATERFOWL**  
Un fucile ideale per caccia di palude. Con la cameratura 12-3,5" (12/89 mm) e la sua bascula in acciaio forgiato, può sparare cariche veramente pesanti. Il WATERFOWL con camera 12M 3" (12/76 mm) con estrattori automatici è un perfetto fucile "tutta caccia". Tutte le versioni prevedono 5 strozzatori intercambiabili e 2 In-Out che prolungano la canna di 50 mm (2").

F

**WATERFOWL**  
Un fusil idéal pour le gibier d'eau et les migrateurs. Avec sa chambre 12-3,5" (12/89 mm) et sa bascule en acier forgé, il peut tirer des charges très lourdes. Le WATERFOWL calibre 12 Magnum (12/76) est avec éjecteurs et est un parfait fusil tout-terrain. Tous sont livrés avec 5 INNERCHOKES et 2 prolonges de canon de 50 mm (2").

E

**WATERFOWL**  
Escopeta ideal para la caza en zonas acuosas. Recámara de 3,5", bástula de acero forjado puede disparar cartuchos muy fuertes. El modelo WATERFOWL con recámara de 3" y con expulsores automáticos es una escopeta todo terreno. Se suministra con 5 chokes internos más 2 de extensión de 50mm.

P

**WATERFOWL**  
A arma ideal para caça às aves aquáticas. Com calibre 12, câmara 89 mm e bástula em aço forjado, pode disparar cargas extremamente pesadas. O modelo WATERFOWL calibre 12, câmara 76mm, vem equipado com ejetores automáticos e é a arma todo-o-terreno perfeita. Fornecidas com 5 INNERCHOKES, e 2 aumentos do cano 50 mm.

ALPHA

A shotgun with a restrained price, which is a superb demonstration of the FABARM's know-how. No compromise on quality. The engraving is unique in its clarity. The ALPHA is made with a forged steel receiver or in Ergal 55 (version ALPHA AL). It comes with a 5 INNERCHOKES (titanium protected) and a gunslip included. An ALPHA ST version is also with extractors.

ALPHA

Un fucile con un prezzo contenuto, ma di qualità molto elevata, grazie all'esperienza accumulata da FABARM in tanti anni di attività. L'incisione ha una personalità molto forte che rende il modello ALPHA facilmente riconoscibile. Il modello ALPHA impiega una bascula realizzata partendo da un forgiato di acciaio speciale oppure da un blocco di Ergal (versione ALPHA AL). Viene fornito con 5 strozzatori INNERCHOKES rivestiti in titanio e un fodero. La versione ALPHA ST è dotata di estrattori.

ALPHA

Un fusil avec un prix contenu, qui est aussi une superbe démonstration du savoir-faire FABARM. Aucun compromis sur la qualité. La gravure a une vraie forte personnalité. L'ALPHA possède une bascule en acier forgé ou en ERGAL 55 sur la version ALPHA AL. Il est livré avec 5 INNERCHOKES (protection titane) et un fourreau. Une version ALPHA ST est disponible avec extracteurs.

ALPHA

Una escopeta con relación calidad precio inigualable que solo FABARM con su experiencia es capaz de lograr. Con un grabado que da personalidad a este modelo el modelo ALPHA se fabrica con una bástula de acero forjado o de Ergal 55 (versión ALPHA AL). Se presenta con 5 choques internos (protegidos con titanio). La versión ALPHA ST es con expulsores no automáticos.

ALPHA

Uma arma de preço reduzido sem comprometer a qualidade: uma excelente demonstração do know-how FABARM. Gravura com forte personalidade. A ALPHA tem uma bástula em aço forjado ou em Ergal 55 (versão ALPHA AL). Inclui 5 INNERCHOKES, com protecção 100% em titânio. Versão ALPHA ST, é sem extractores automáticos.

	WATERFOWL 3" CAMO	WATERFOWL 3.5" CAMO (I)	ALPHA FIELD	ALPHA AL (*)	ALPHA FIELD ST (*) (I)
GAUGE	12/3" (12/76)	12/3,5" (12/89)	12/3" (12/76)	12/3" (12/76)	12/3" (12/76)
	76/30"	76/30"	66/26" - 71/28" - 76/30"	66/26" - 71/28"	71/28" - 76/30"
CHOKES	INNERCHOKES (5) + 2 IN/OUT 50 mm	INNERCHOKES (5) + 2 IN/OUT 50 mm	INNERCHOKES (5)	INNERCHOKES (5)	INNERCHOKES (5)
RIB (mm)	7	7	7	7	7
	PISTOL	PISTOL	PISTOL	PISTOL	PISTOL
	367	367	367	367	367
	TULIP	TULIP	TULIP	TULIP	TULIP
WOOD FINISH	HARDWOODS GREEN HD OR ADVANTAGE MAX 4	ADVANTAGE MAX 4	OILED	OILED	OILED
RECEIVER	FORGED STEEL	FORGED STEEL	FORGED STEEL	ERGAL 55	FORGED STEEL
RECEIVER FINISH	HARDWOODS GREEN HD OR ADVANTAGE MAX 4	ADVANTAGE MAX 4	TENIFER	GREY PEARL	TENIFER
	•	•	CARTON BOX	CARTON BOX	CARTON BOX
KG	3,10	3,30	2,95 - 3,15	2,70 - 2,80	3,00 - 3,10

(I) No automatic ejector  
(\*) Product non shown

C O N T I N U I T I



# SHOOTING LINE

## SHOOTING LINE



OVER & UNDER

**GB** A revolutionary shotgun with revolutionary choke tubes. The AXIS SPORTING has EXIS HP™ choke tubes, 92 mm long with our exclusive and patented hyperbolic profile. The AXIS is a new shotgun generation, made for intensive use with premium material, adjustable opening tension and a design studied in terms of ergonomics.

**I** Un fucile rivoluzionario con i suoi rivoluzionari strozzatori. L'AXIS SPORTING è dotato di strozzatori EXIS HP™ di 92 mm di lunghezza e con un esclusivo e brevettato profilo interno iperbolico. L'AXIS è un fucile della nuova generazione costruito per un uso intenso, utilizzando i migliori materiali. La tensione della cerniera regolabile con un design tanto ergonomico quanto moderno.

**F** Un fusil révolutionnaire avec des chokes révolutionnaires. L'AXIS SPORTING possède des chokes EXIS HP™ d'une longueur de 92 mm avec notre profil hyperbolique exclusif et breveté. L'AXIS est un fusil de nouvelle génération, réalisé avec des matériaux de premier ordre, une charnière à tension réglable et un design pensé en terme d'ergonomie.

**E** Un escopeta revolucionaria con un revolucionario sistema de chokes. El modelo AXIS SPORTING tiene un tubo EXIS HP™ de 92 mm de largo con nuestro exclusivo y patentado sistema hiperbolico. El modelo AXIS es una nueva generación de escopeta hechas para un uso intensivo, usando materiales de primera línea, un sistema ajustable de tensión y un diseño estudiado entérminos ergonomicos.

**P** Uma arma revolucionária com chokes revolucionários. A AXIS SPORTING está equipada com o chokes EXIS HP™, 92 mm de comprimento com o nosso exclusivo e patenteado perfil hiperbólico. A AXIS representa uma nova geração de armas, desenvolvida para uso intensivo com material de primeira qualidade, tensão da extracção regulável e um design altamente estudado em termos de ergonomia.

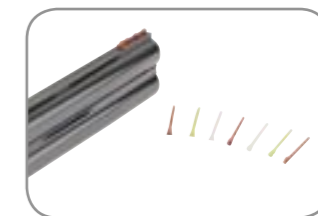

Interchangeable optic fiber sights : triangle or rounded inserts.  
 Mirini in fibra ottica con inserti intercambiabili tondi o triangolari.  
 Guidons interchangeables en fibre optique : inserts ronds ou triangulaires.  
 Miras de fibra óptica intercambiables: insertos redondos o triangulares.  
 Pontos de mira em fibra óptica intercambiáveis: forma triangular ou cilíndrica.

# AXIS SPORTING



INTEGRALE™  
CASE

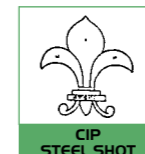

AXIS SPORTING



AXIS SPORTING PORTED AS

AXIS SPORTING	
GAUGE	12/3" (12/76)
	71/28" - 76/30" - 81/32"
CHOKES	EXIS HP (5) CYL - SHORT - MEDIUM - LONG - XTREME
RIB (mm)	10
	REGULAR OR ADJUSTABLE
	372
WOOD FINISH	OILED
RECEIVER FINISH	TITANIUM
	• INTEGRALE™
KG	3,45 - 3,60

Option: ported barrel



5 EXIS HP™ (hyperbolic profile) 92 mm long.  
 5 EXIS HP™ (profilo iperbolico) 92 mm di lunghezza.  
 5 EXIS HP™ (profil hyperbolique) d'une longueur de 92 mm.  
 5 EXIS HP™ (perfil hiperbolico) largo de 92 mm.  
 5 EXIS HP™ (perfil hiperbolico) comprimento de 92 mm.



An adjustable trigger for 6 positions.  
 Grilletto regolabile in 6 posizioni.  
 Une détente réglable à 6 positions.  
 Disparador ajustable de 6 posições.  
 Disparador ajustable en 6 posiciones.

**GB** The AXIS TRAP demonstrates how high performance and beauty can be perfectly matched. A true competition shotgun from end to end with a low profile receiver in forged steel, tapered top rib, adjustable trigger for 6 positions, adjustable opening system, specific recoil pad and fibre optic front sight with interchangeable lite pipes.

The AXIS TRAP has an oil finished stock (regular or adjustable) and comes in INTEGRALE™ case.

**I** L'AXIS TRAP è la prova di come bellezza ed elevate performances possano essere perfettamente unite. Un autentico fucile da competizione, bascula con profilo basso in acciaio forgiato, bindella conica, grilletto regolabile in 6 posizioni, cerniera a tensione regolabile, calcio specifico e mirino anteriore in fibra ottica con inserti intercambiabili.

L'AXIS TRAP ha un calcio finito ad olio (tradizionale o regolabile) ed è consegnato in valigetta INTEGRALE™.

**F** L'AXIS TRAP démontre comment hautes performances et beauté peuvent être parfaitement combinées. Une véritable arme de compétition, avec bascule basse en acier forgé, bande de visée conique, détente réglable à 6 positions, charnière à résistance réglable, plaque de couche spécifique et guidon en fibre optique avec inserts interchangeables.

L'AXIS TRAP possède une crosse en finition huilée (classique ou réglable) et est livré en valise INTEGRALE™.

**E** El modelo AXIS TRAP es una clara demostración de como la elegancia y la alta tecnología en la fabricación de una arma van de la mano. Una autentica escopeta de competición de principio a fin, báscula de perfil bajo de acero forjado, disparador ajustable en 6 posiciones, sistema ajustable de apertura, cantonera especial, miras de fibra óptica intercambiables.

El modelo AXIS TRAP esta también disponible en versión acabado de cualata al aceite, con culata regulable. Es suministrada en un estuche INTEGRALE™.

**P** A AXIS TRAP demonstra como a performance ao mais alto nível e beleza podem ser combinadas na perfeição. Uma verdadeira arma de competição de ponta a ponta, com báscula em aço forjado, fita de mira cônica, gatilho regulável em 6 posições, tensão de abertura regulável, calço específico para a arma e pontos de mira em fibra óptica intercambiáveis.

A AXIS TRAP tem a coronha com acabamento a óleo (clássica ou regulável) e é fornecida com mala INTEGRALE™.



5 EXIS HP™ (hyperbolic profile) 92 mm long.  
 5 EXIS HP™ (profilo iperbolico) 92 mm di lunghezza.  
 5 EXIS HP™ (profil hyperbolique) d'une longueur de 92 mm.  
 5 EXIS HP™ (perfil hiperbolico) largo de 92 mm.  
 5 EXIS HP™ (perfil hiperbolico) comprimento de 92 mm.

# AXIS TRAP



	AXIS TRAP	AXIS TRAP EXIS HP AS
GAUGE	12-2 3/4" (12/70)	12-3" (12/76)
CHOKES	76/30"	76/30" - 81/32"
RIB (mm)	IM - F	EXIS HP (5)
	IO	IO
	REGULAR OR ADJUSTABLE	REGULAR OR ADJUSTABLE
	375	375
	SEMI-BEAVERTAIL	SEMI-BEAVERTAIL
WOOD	OILED	OILED
RECEIVER FINISH	TITANIUM	TITANIUM
	● INTEGRALE™	● INTEGRALE™
KG	3,60	3,60 - 3,65

Adjustable stock: vertical adjustment 12mm, lateral adjustment 10 mm.  
 Calcio regolabile: sono possibili regolazioni verticali fino a 12 mm e laterali fino a 10 mm.  
 Crosse adjustable: réglage vertical 12mm, réglage latéral 10 mm.  
 Culata regulables: regulable verticalmente en 12mm y lateralmente en 10mm.  
 Coronha ajustável: regulação vertical 12mm, regulação lateral de 10mm.

**GB** The STL barrel has a specific top rib with a tapered muzzle profile ranging from 10 to 8 mm and a concave checkering profile. With its interchangeable HIZVIZ optic fiber sights (10 lite pipes), the STL meets the highest standards. Its forend bracket is 100% titanium coated. Open a STL... and see the difference with competitive shotguns. The STL SPORTING is delivered with 8 EXIS choke tubes. The full titanium coating, the long EXIS length (62 mm) added with a TRIBORE® barrel, ensure a non equalled shot distribution.

**I** La canna dell'STL ha una speciale bindella superiore concava e trapezoidale, con una larghezza che varia dai 10 agli 8 mm. Con i suoi 10 mirini HIZVIZ intercambiabili in fibra ottica, l'STL soddisfa le necessità dei tiratori più esigenti. La croce dell'astina è rivestita in titanio: provate ad aprire un STL e vedrete la grande differenza che c'è con tutti gli altri fucili della concorrenza. L'STL SPORTING è fornito di 8 strozzatori EXIS. Il rivestimento in titanio, la lunghezza degli strozzatori (62 mm) assieme alla canna TRIBORE® assicurano un'ottimale distribuzione dei pallini.

**F** Le canon STL possède une bande de visée fuyante de 10 à 8 mm et un guillochage concave. Avec ses guidons interchangeables HIZVIZ (10 inserts), le STL répond aux plus hauts standards. Son crochet est intégralement recouvert de titane. Ouvrez un STL... et voyez la différence par rapport aux armes concurrentes. Le STL SPORTING est livré avec 8 chokes EXIS. Le traitement high-tech titane, la longueur de 62 mm des chokes et le profil TRIBORE® du canon garantissent un rendement balistique sans égal.

**E** El cañón STL tiene una banda superior específica de 10 a 8mm y un perfil de picado cóncavo. Con sus miras HIZVIZ intercambiables (10 pipas de fibra óptica), el STL responde a los standards más exigentes. La palanquilla de apertura de la delantera está recubierta 100% titanio. Abra una STL, y compare la diferencia con otras armas. El modelo STL SPORTING se suministra con 8 choques EXIS. La total cobertura de titanio. La longitud de los choques EXIS (62mm) junto con el cañón TRIBORE®, aseguran una distribución de disparo inigualable.

**P** A STL possui um cano com fita côncava e convergente de 10 a 8mm, à ponta do cano. Com os pontos de mira em fibra óptica intercambiáveis da HIZVIZ (10 no total), a STL responde às mais altas exigências. A fecharia do fuste é totalmente revestida a titânio. Abra uma STL... e veja a diferença para as armas da concorrência. A STL SPORTING é fornecida com 8 chokes EXIS. O acabamento em titânio high-tech, chokes de 62mm integrados no sistema do cano TRIBORE®, garantem performances balísticas sem igual.

# STL VS SPORTING

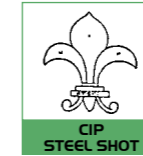

STL VS SPORTING AS



Delivered with 8 EXIS choke tubes 100 % titanium protected.  
Consegnato con 8 strozzatori EXIS rivestiti al 100% in titanio.  
Livré avec 8 chokes EXIS protection 100 % titane.  
Se envía con 8 choques 100% recubiertos de titanio.  
Entregue com 8 chokes EXIS com protecção 100% em titânio.



ALUMINIUM CASE

STL VS SPORTING AS	
GAUGE	12/3" (12/76)
CHOKES	71/28"-76/30"- 81/32"
RIB (mm)	EXIS (8)
	10-8
	REGULAR OR ADJUSTABLE
	372
WOOD	TULIP
RECEIVER FINISH	OILED
	TENIFER
	ALUMINIUM
KG	3,50 - 3,65



An ergonomic and modern top lever.  
Una chiave d'apertura moderna ed ergonomica.  
Clé moderne et ergonomique.  
Palanca de apertura moderna y ergonómica.  
Alavanca moderna e ergonómica.



**GB** The grey satin of the receiver in forged steel, the gold plating of the FABARM logo, the 100% titanium coating of the top lever, the trigger guard and the forend bracket... the GAMMA 2 has without question sophisticated and harmonious features. A perfect ergonomomy, a laser chequering, our exclusive TRIWOOD finish, an interchangeable recoil pad on the sporting model, with the GAMMA 2 you will use this shotgun with un-parallel confidence. It comes with 8 EXIS chokes tubes, 100% titanium protected (fixed chokes on the TRAP version).

**I** Tutte le superfici subiscono trattamenti innovativi ed esclusivi per aumentare la vita utile del fucile. Il grigio satinato della bascula in acciaio, il logo FABARM dorato, il rivestimento in titanio 100% della chiave di apertura, della guardia del grilletto e della croce dell'astina... tutti particolari che trasformano il modello GAMMA 2 in un sovrapposto ricercato e particolarmente armonioso. Lo zigrino laser, la nostra esclusiva finitura dei legni TRIWOOD, il calciolo in gomma intercambiabile sui modelli Sporting, proiettano il GAMMA 2 nel futuro. Viene consegnato con 8 strozzatori EXIS rivestiti in titanio (canne a strozzatura fissa nella versione TRAP).

**F** Le gris satiné de la bascule en acier forgé, le logo FABARM doré, la protection 100% titane de la clef, du pontet et du crochet... le GAMMA 2 a assurément des caractéristiques sophistiquées et harmonieuses. Une ergonomie parfaite, des quadrillages laser, notre finition exclusive TRIWOOD, une plaque de couche interchangeable sur la version Sporting. Avec le GAMMA 2 vous utilisez une arme avec un esprit sportif très fort. L'arme est livrée avec 8 chokes EXIS ayant une protection 100 % titane (chokes fixes sur la version TRAP).

**P** O cinza satinado da bscula em ao forjado, o logo dourado da FABARM, a proteco 100% titnio da alavanca, do guarda mato e da fecharia do fuste... a GAMMA 2 apresenta caractersticas sofisticadas e harmoniosas. Uma ergonomia perfeita, os quadrilhados laser, o nosso acabamento exclusivo TRIWOOD, um calo intercambivel na verso Sporting. A GAMMA 2  uma arma com um forte esprito desportivo. Equipada com 8 chokes EXIS, com proteco 100% titnio (verso TRAP com chokes fixos).

**E** El acabado en gris de la bscula de acero forjado, el logo FABARM, grabado en letras de oro, la palanquilla de apertura recubierta de titanio 100% el guardamonte; la palanquilla de la delantera... el modelo GAMMA 2 es una escopeta perfecta que combina seguridad, fiabilidad y ergonoma. Nuevo diseo de culata y delantera. Ergonmicamente perfecta, picadura por laser, acabado exclusivo TRIWOOD, cantonera intercambiable en el modelo sporting, con el modelo GAMMA 2 Vd. tendr una escopeta con un marcado sentido deportivo. Se presenta con 8 choques EXIS, recubiertos al 100% con titanium (choques fijos en la versin TRAP).

# GAMMA 2



GAMMA 2 SPORT AS

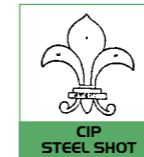

A receiver with a very nice grey satin-finish and a modern top lever.  
La bascula con una finitura grigia satinata e una moderna chiave d'apertura.  
Une superbe finition gris satine de la bascule associe à une cl moderne.  
Una bscula con un bonito gris satinado y una moderna palanquilla de apertura.  
Bscula com acabamento suberbo em cinza satinado e alavanca moderna.

GAMMA 2 TRAP

GAMMA 2 SPORT 3T



	GAMMA 2 SPORTING	GAMMA 2 TRAP
GAUGE	12-3" (12/76)	12-2 3/4" (12/70)
CHOKES	71/28" - 76/30"	76/30"
RIB (mm)	EXIS (8)	IM - F
	10	10
	REGULAR OR ADJUSTABLE	REGULAR OR ADJUSTABLE
	372	375
	TULIP	SEMI-BEAVERTAIL
WOOD FINISH	TRIWOOD	TRIWOOD
RECEIVER FINISH	TENIFER OR TRIKOLOR (3T)	TENIFER OR TRIKOLOR (3T)
KG	3,50 - 3,60	3,60



### PULSE PISTON™



**PATENTED**

- ✓ PERFECT WITH ALL SHOTSHELLS - PERFETTO CON OGNI CARTUCCIA - PARFAIT AVEC TOUTES LES CARTOUCHES - PERFECTO CON TODO TIPO DE CARTUCHOS - PERMITE USAR TODOS OS CARTUCHOS
- ✓ IT REDUCES THE RECOIL - RIDUCE IL RINCULO - REDUIT LE RECOL - REDUCE EL RETROCESO - REDUZ O RETROCESSO
- ✓ EASY TO CLEAN - FACILE DA PULIRE - NETTOYAGE FACILE - FACIL DE LIMPIAR - FÁCIL DE LIMPAR

A piston with a soft polymer insert to regulate the reloading; it works like a progressive break in the gas cylinder. No more valve, resulting in the ability to cycle with all types of ammunitions with an incredible recoil reduction.

Un pistone con un inserto in elastomero per regolarizzare al massimo il ciclo di riarmo del fucile che agisce anche da freno all'interno del cilindro presa gas. Il Pulse dà la possibilità di sparare tutti i tipi di cartucce con una sorprendente riduzione del rinculo.

Un piston avec un insert flexible en polymère pour réguler le réarmement : il travaille tel un frein progressif à l'intérieur du cylindre de gaz. Plus de valve et la possibilité, plus que jamais, de tirer tous les types de cartouches avec une incroyable réduction du recul.

Un pistón con una parte fabricada en polimero flexible para regular la recarga; trabaja como un freno progresivo en el interior del cilindro de gas. No más válvulas y con la posibilidad más que nunca, de disparar todo tipo de cartuchos con una increíble reducción del retroceso.

PULSE PISTON o pistão com um entalhe em polímero, regula o rearme actuando como um travão progressivo no interior do cilindro. Não necessita de qualquer válvula e permite a utilização de qualquer tipo de munição com uma incrível redução do retrocesso.

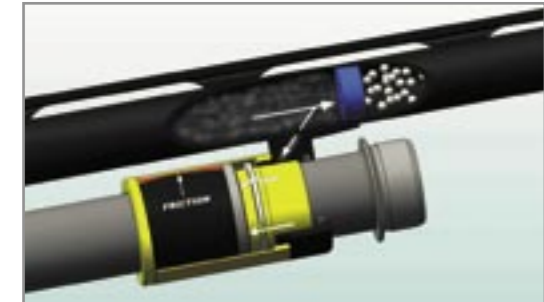

The pressure compresses the elastomere. The insert works as a brake. La pressione comprime l'elastomero. L'inserto lavora come un freno. La forte pression des gaz comprime l'elastomère. Cet insert agit dès lors tel un frein. La presión comprime el elastomero. El inserto trabaja como freno. A pressão comprime o elastomero. O entalhe, funciona como um travão.

### THE LOWEST RECOIL IL MINORE RINCULO LE PLUS FAIBLE RECOL EL MAS BAJO RETROCESO O MENOR RETROCESSO

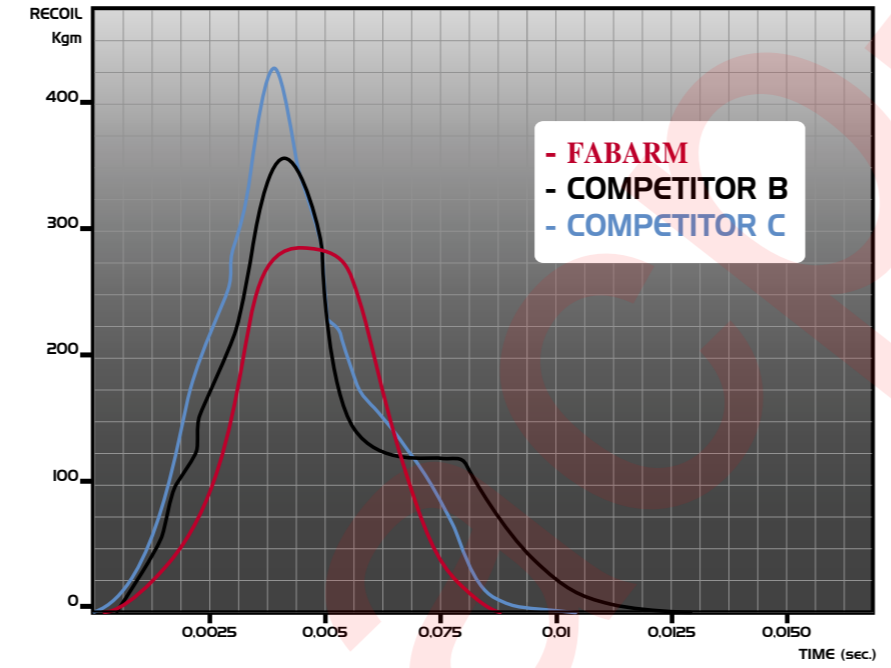

### TRIBORE® BARREL

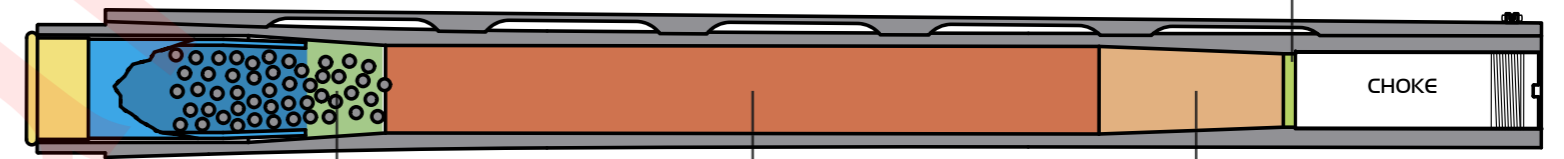

Extra long forcing cone  
Cono di raccordo extra lungo  
Très long cône de raccordement  
Cono extra largo  
Cone de aceleração extra-longo

Over bored area: 18,8 mm  
Zona sovralesata: 18,8 mm  
Zone suralésée: 18,8 mm  
Anima 18,8 mm  
Almas sobredimensionadas: 18,8 mm

Cylindrical area: 5mm  
Zona cilindrica di 5 mm  
Zone cylindrique de 5 mm  
Zona cilíndrica de 5 mm  
Zona cilíndrica de 5 mm

Conical area (205 mm) which slowly reduces the bore to 18,4 mm  
Parte conica di 205 mm che riduce progressivamente il diametro a 18,4 mm  
Zone conique (205 mm) qui réduit progressivement le diamètre à 18,4 mm  
Zona cónica de 205 mm que reduce progresivamente el diámetro a 18,4 mm  
Zona cónica (205 mm) que reduz progressivamente o diâmetro até 18,4mm

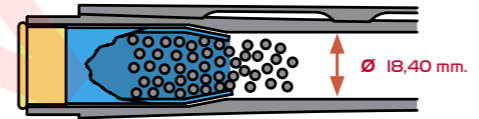

NON TRIBORE

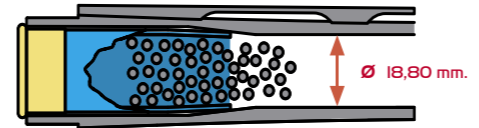

TRIBORE

BARREL: 71cm. (28")  
36 g  
cal 12  
N° 6  
Plastic wad  
CHOKEMODIFIED (\*\*\*)

Distance 35m  
ø 75 cm.



### THE BEST DISTRIBUTION LA MIGLIORE ROSATA LE MEILLEUR RENDEMENT BALISTIQUE EL MEJOR PLOMEO A MELHOR DISTRIBUIÇÃO

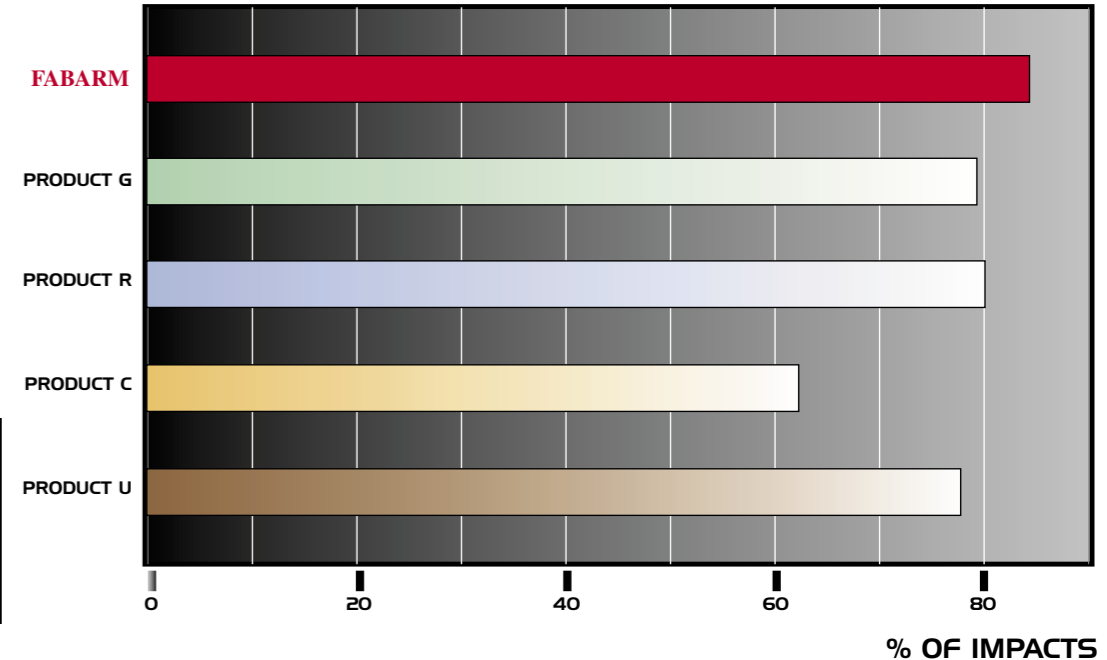

% OF IMPACTS

**THE FASTEST RELOADING CYCLE**  
**IL PIU' VELOCE CICLO DI RIARMO**  
**LE CYCLE DE REARMEMENT LE PLUS RAPIDE**  
**EL MAS RAPIDO CICLO DE RECARGA**  
**O MAIS RAPIDO CICLO DE RECARREGAMENTO**

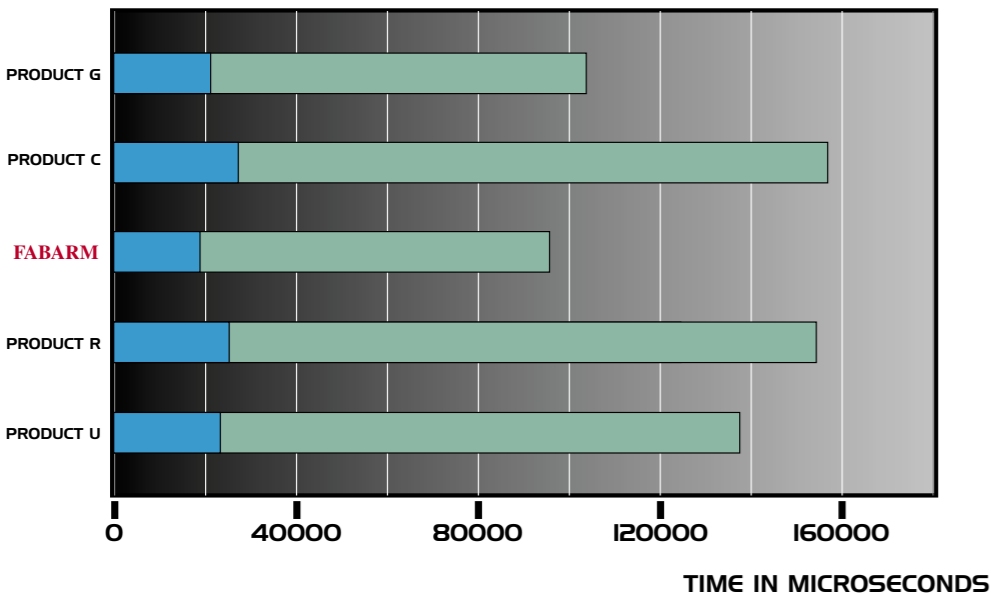
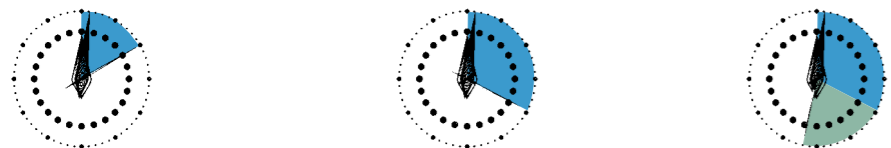

**THE MOST STABLE SEMI-AUTO SHOTGUN**  
**L'AUTOMATICO PIU' STABILE**  
**LE FUSIL SEMI-AUTO LE PLUS STABLE**  
**LA SEMI-AUTO MAS FIABLE**  
**A SEMI-AUTOMATICA MAIS ESTÁVEL**



MUZZLE JUMP in mm  
 ALZATA DELLA CANNA in mm  
 RELEVEMENT DU CANON en mm  
 ELEVACION DEL CAÑON en mm  
 ELEVAÇÃO DO CANO em mm

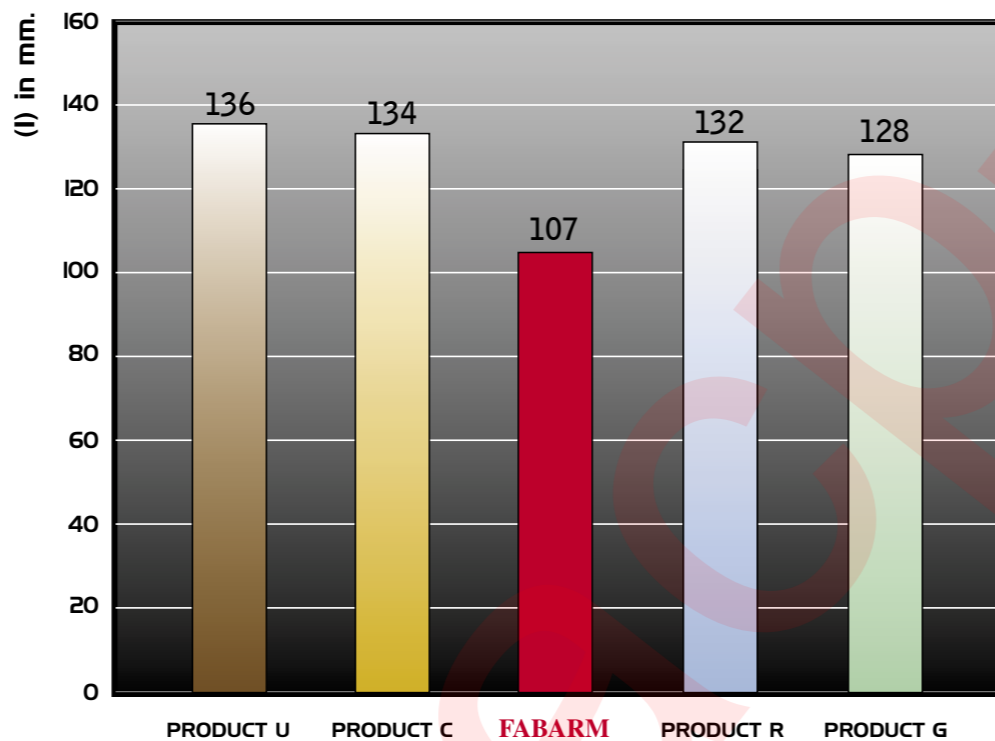

**TITANIUM PROTECTION**

- EXTREME CORROSION RESISTANCE
- ECCELLENTE RESISTENZA ALLA CORROSIONE
- EXTREME RESISTANCE A LA CORROSION
- EXTREMA RESISTENCIA ANTI CORROSIÓN
- RESISTÊNCIA EXTREMA A CORROÇÃO

Corrosion test in artificial atmosphere: neutral salt spray.  
 Prove di corrosione in atmosfere artificiali: prove in nebbia salina.  
 Test de corrosion en atmosphère artificielle: test aux brouillards salins.  
 Prueba de corrosion en atmosfera artificial: prueba en niebla salina.  
 Teste de corrosão em atmosfera artificial: exposição a ambiente de sais corrosivos.

**TEST ISO 9227**



FABARM AFTER 100h

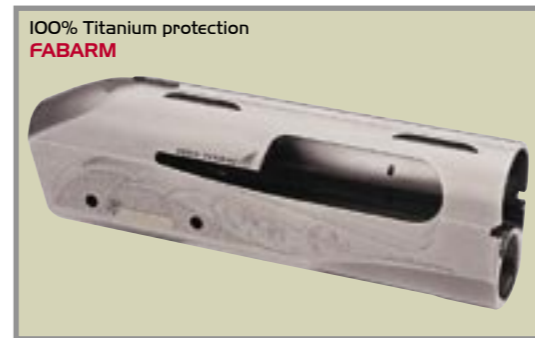

- LION H35 EXCLUSIVE
- LION H35 TITAN
- LION H35 AZUR
- LION H38 LUXE

**STRONG ACTION BAR**  
**ROBUSTO CARRELLO-BIELLA**  
**ROBUSTE BRAS DE COMMANDE**  
**ROBUSTA ASTA DE ARMAMENTO**  
**GUIA DA CULATRA ROBUSTA**

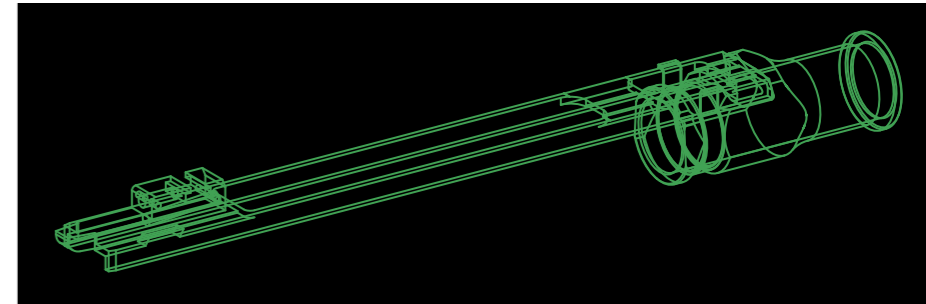

**CAPACITY**  
**CAPACITA'**  
**CAPACITE**  
**CAPACIDAD**  
**CAPACIDADE**

**LION H35**



SHOTS

2+1

4+1

**LION H38 - LION H368**



2+1

5+1

7+1

**GB** When the word "EXCLUSIVE" has all its sense... The LION H35 EXCLUSIVE has a extraluxe category walnut with rosewood recoil pad. A deep relief engraving garnishes the entire frame. The barrel with the brand new INNER HP™ (Hyperbolic choke tubes, 82 mm long) warranty unequalled pattern results. All the shotguns are numbered and delivered with a certificate. It comes in a prestigious leather guncase.

**I** Quando il termine "EXCLUSIVE" ha davvero tutto il suo senso... Lion H35 EXCLUSIVE monta legni di noce sceltissima di grado elevato con calciolo in legno di radica. La carcassa è interamente incisa in modo profondo ed evidente. La canna presenta i nuovissimi strozzatori iperbolici INNER HP™ da 82 mm di lunghezza, a garanzia di prestazioni eccezionali. Tutti i fucili sono numerati e spediti con il relativo certificato. La valigetta è veramente prestigiosa e realizzata in pelle di qualità.

**F** Quand le mot "EXCLUSIVE" prend tout son sens... Le LION H35 EXCLUSIVE a une crosse en noyer de qualité grand luxe, une plaque de couche bois. Une profonde gravure orne l'ensemble de la carcasse. Le canon avec les tout-nouveaux INNER HP™ (chokes hyperboliques d'une longueur de 82 mm) garantit des groupements sans égal. Tous les fusils sont numérotés et accompagnés d'un certificat. Il est livré dans une prestigieuse valise en cuir.

**E** La palabra "EXCLUSIVO" adquiere todo su significado cuando nos referimos al modelo LION H35 EXCLUSIVE. Culata de nogal seleccionado, cantonera de madera, grabado profundo que embellece la carcasa, cañones con el nuevo sistema INNER HP™ (chokes Hyperbólicos de 82 mm de largo). Plomeo garantizado. Todas las escopetas son numeradas y embaladas con un certificado de calidad y ajustadas a un estuche de cuero especialmente diseñado para FABARM.

**P** Quando a palavra "EXCLUSIVE" tem todo o seu sentido... A LION H35 EXCLUSIVE tem uma coronha em madeira de nogueira de qualidade de luxo com pormenor do calço em madeira. Uma profunda gravura ornamenta a totalidade da bácia. O cano com chokes INNER HP™ (perfil hiperbólico, 82 mm comprimento) garante prestações de tiro inigualáveis. Todas as armas são numeradas e entregues com certificado. É fornecida com uma mala em pele de grande qualidade.



4 INNER HP™ (hyperbolic profile) 82 mm long.  
4 INNER HP™ (profilo iperbolico) 82 mm di lunghezza.  
4 INNER HP™ (profil hyperbolique) d'une longueur de 82 mm.  
4 INNER HP™ (perfil hiperbolico) largo de 82 mm.  
4 INNER HP™ (perfil hiperbolico) comprimento de 82 mm.

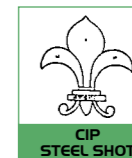

# LION H35 EXCLUSIVE



LION H35 EXCLUSIVE





Stock with wood recoil pad.  
Calcio con calciolo in legno.  
Crosse avec plaque de couche bois.  
Culata con cantonera de madera.  
Coronha com calço em madeira.

LEATHER CASE



Limited edition "one of thousand".  
Edizione limitata "da uno a mille".  
Edition limitée "un de mille".  
Edición limitada "1 de mil".  
Série limitée "um de mil".

**\*\*LION H35: 3 or 5 SHOTS!**

LION H35 EXCLUSIVE	
GAUGE	12/3" (12/76)
RIB (mm)	6
TOTAL CAPACITY*	3 OR 5
CHOKES	SHORT - MEDIUM - LONG - XTREME
MOD.	INNER HP (HYPERBOLIC PROFILE)
	66/26"-71/28"-76/30"
	365
WOOD FINISH	EXTRA LUXE OILED
	• LEATHER
KG	2,80 - 3,00

(\*) With 2 3/4" ammunitions

(\*\*) In accordance with legal constraints

In option: INNER HP ULTIMATE - INNER HP PARADOX



The frame with its full 100% titanium protection.  
La carcassa è rivestita al 100% in titanio.  
La carcasse avec son intégrale protection 100% titane.  
La carcassa esta 100% TITANIUM protección.  
Carcaca com protecção 100% em titânio.



**GB** How to perfectly combine an innovative shotgun with an exclusive and prestigious finish? The LION H35 AZUR is without question a new luxury vision, where all details are studied with sense of aestheticism: the receiver 100% titanium protected is engraved with refined arabesques and ceramic. The cocking handle has a unique profile. Specific finish also on the wood with a TRIWOOD 100, associated with a wood recoil pad, oiled (an additional rubber recoil pad is also delivered). The LION H35 AZUR comes in the ESTHETE™ case.

**I** Come è possibile abbinare a un fucile innovativo una finitura esclusiva e prestigiosa? LION H35 AZUR è senza dubbio una nuova e lussuosa espressione dove ogni dettaglio è stato studiato con senso estetico: la carcassa protetta 100% titanio, incisa con fini arabeschi, e presenta inserti in ceramica. La manetta di armamento ha un profilo molto esclusivo. I legni presentano una finitura TRIWOOD 100, mentre il calciolo è realizzato in legno finito ad olio (la dotazione prevede un addizionale calciolo in gomma intercambiabile). LION H35 AZUR viene fornito in valigetta ESTHETE™.

**F** Comment associer parfaitement la modernité d'une arme avec des finitions exclusives et prestigieuses ? Le LION H35 AZUR est assurément une nouvelle vision du luxe, où chaque détail a été pensé avec un réel sens de l'esthétisme: la carcasse protégée 100% titane est gravée avec de fines arabesques et de la céramique. Le doigt d'armement a un profil exclusif. Finition spécifique également des bois avec un TRIWOOD 100 et une plaque de couche en bois huilé (un sabot anti recul supplémentaire est également inclus). Le LION H35 AZUR est livré dans notre valise ESTHETE™.

**E** ¿Cómo combinar una escopeta innovadora con un exclusivo y elegante acabado? El modelo LION H35 AZUR es una nueva óptica de la estética en las armas. La carcasa 100% protegida por titanio, esta además grabada con refinados arabescos y cerámicas. La maneta esta con un exclusivo diseño. Acabado especial en la madera con el TRIWOOD 100; cantonera de madera (se envia tambien una cantonera de goma). Se suministra con estuche ESTHETE™.

**P** Como combinar uma arma inovadora com um acabamento exclusivo e de prestígio? A LION H35 AZUR, é sem dúvida uma nova visão do luxo, onde todos os detalhes foram estudados com verdadeiro sentido estético: a caixa da culatra, com protecção 100% em titânio, é gravada com finos arabescos e cerâmica. O puxador da culatra, tem um perfil exclusivo. Acabamento específico também nas madeiras, com TRIWOOD 100, juntamente com um calço em madeira oleada (calço em borracha também fornecido). A LION H35 AZUR é fornecida com a mala ESTHETE™.



**\*\*LION H35: 3 or 5 SHOTS !**

LION H35 AZUR	
GAUGE	12/3" (12/76)
RIB (mm)	6
TOTAL CAPACITY*	3 OR 5
CHOKES	C-IC-M-IM-F + IN/OUT 50mm
MOD.	INNERCHOKES
Length	61/24"- 66/26"-71/28"-76/30"
Weight	365
WOOD FINISH	TRIWOOD 100
	• ESTHETE
KG	2,80 - 3,00

(\*) With 2 3/4" ammunitions

(\*\*) In accordance with legal constraints

Delivered with 2 pads; to choose between wood or rubber.  
Fornito con 2 calcioli: scelta tra calciolo in legno o gomma.  
Livré avec 2 plaques de couche, pour choisir entre bois ou caoutchouc.  
Suministrado con dos cantoneras, a elegir entre madera o goma.  
Fornecida com 2 calços, para escolher entre madeira e borracha.

ESTHETE™  
CASE



Exclusive ceramic inlays.  
Gli esclusivi inserti in ceramica.  
Insert en céramique; une exclusivité FABARM.  
Insertos exclusivos de cerámica.  
Entalhes em cerâmica; um exclusivo FABARM.



Exclusive cocking handle.  
Manetta di armamento esclusiva.  
Doigt d'armement exclusif.  
Maneta.  
Puxador de culatra.

A green optic fiber insert to improve the sighting.  
Inserto in fibra ottica verde per migliorare l'acquisizione della mira.  
Insert en fibre optique verte pour améliorer la visée.  
Inserto de fibra óptica para mejorar el encare.  
Entalhe em fibra optica verde para melhorar o encare.

**GB** The LION H35 TITAN doesn't look like any shotgun you've seen before. Its receiver 100 % titanium protected is simply the best there is in terms of hardness, resistance to abrasion or to corrosion. All other features are also perfectly studied : the quick release sling swivels, the interchangeable and very soft recoil pad, a black nylon insert on the bottom of the receiver for a quick and precise sighting. With its innovative engraving and chequering, its curves, its magazine cap and tulip forend the shape is elegant, modern, fluid with a real sense of aestheticism. The LION H35 TITAN is also the lightest semi-auto shotgun available on the worldwide market. No more than 3,00 Kg with a 30" barrel!

**I** Il LION H35 TITAN è un'arma mai vista prima. La carcassa è rivoluzionaria grazie al rivestimento in titanio. Questo rivestimento anti-riflesso è il migliore per quanto riguarda la durezza, la resistenza all'abrasione e alla corrosione. Ma ci sono altre caratteristiche che lo rendono unico: magliette porta-cinghia a sganciamento rapido, calciolo intercambiabile molto morbido, inserto in nylon nero per un veloce e preciso allineamento con il mirino. L'incisione innovativa, lo zigrino dei legni, le gradevoli linee curve, l'originale tappo serbatoio, l'astina a tulip lo rendono particolarmente moderno e molto piacevole dal punto di vista estetico. Il LION H35 TITAN è il semiautomatico più leggero disponibile sul mercato mondiale: con canne da 76cm non pesa più di 3,00 kg!

**F** Le LION H35 TITAN ne ressemble à aucun fusil déjà vu. Il devient même révolutionnaire avec la protection 100 % titane de sa carcasse. Ce revêtement non brillant est le nec plus ultra en termes de dureté, de résistance à l'abrasion et à la corrosion. Toutes ses caractéristiques ont été parfaitement étudiées: les anneaux porte-bretelle instantanément détachables, une plaque anti recul souple et interchangeable, un insert ABS sur le sommet de la carcasse pour une visée rapide et précise. Avec sa gravure et quadrillage innovants, ses lignes, son bouchon de magasin et garde-main tulipe... Son design est élégant, moderne, fluide avec un vrai sens de l'esthétisme. Le LION H35 TITAN est aussi le plus léger des fusils semi-automatiques sur le marché mondial. Pas plus de 3,00 Kg avec un canon de 76 cm!

**E** El modelo LION H35 TITAN no se parece a nada que haya visto antes. Su báscula 100% recubierta de titanio es es lo último en términos de dureza, resistencia a la abrasión o corrosión. Otros detalles están perfectamente estudiados anillas portafusil fácilmente desmontables, cantonera intercambiabile, inserto de nylon negro en la parte baja de la báscula para un rápido y preciso encare. Con un grabado innovador y picado último diseño, sus curvas, su cargador y delantera, presenta una forma elegante, moderna, fluida, con un total sentido estético. El modelo LION H35 TITAN es también la escopeta semi automática más ligera del mercado. No pesa más de 3,00 Kgs y presenta un cañón de 30"!

**P** A LION H35 TITAN não se assemelha a nenhuma arma existente. Revolucionária, com a total protecção em titânio da carcaça. Este acabamento baço, é o que melhor há em termos de durabilidade e resistência à abrasão e corrosão. Mas tem outras características, cuidadosamente estudadas, tais como os zarelhos amovíveis instantaneamente, um calço suave e intercambiável, um entalhe em ABS no topo da carcaça para facilitar o encare. Com uma gravura inovadora, com as suas linhas, com o seu fuste em tulipa, entre outros pormenores, a H35 TITAN tem uma imagem elegante, moderna, fluida, com verdadeiro sentido estético. A LION H35 TITAN, é também a semi-automática mais leve presente no mercado mundial. Não pesa mais de 3,00kg modelo com cano de 76cm!



The frame with its full 100% titanium protection. La carcassa è rivestita al 100% in titanio. La carcasse avec son intégrale protection 100% titane. La carcaça esta 100% TITANIUM protecção. Carcaça com protecção 100% em titânio.

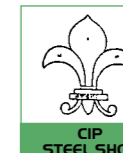

# LION H35 TITAN



LION H35 TITAN



Instantaneous release sling swivels. Portacinghia a sganciamento rapido. Anneaux porte bretelle instantanément détachables. Anillas portafusil fácilmente desmontables. Zarelhos destacáveis instantaneamente.

INTEGRALE™  
CASE



Exclusive: a mechanical free carrier. Esclusivo: un elevatore libero di tipo meccanico. Exclusif: un éleveur libre mécanique. Exclusivo: un elevador libre mecánico. Exclusiva: elevador livre mecánico.

**\*\*LION H35: 3 or 5 SHOTS !**

	LION H35 TITAN	LION H35 TITAN COMBO
GAUGE	12/3" (12/76)	12/3" (12/76)
RIB (mm)	6	
TOTAL CAPACITY*	3 OR 5	
CHOKES	C-IC-M-IM-F + IN/OUT 50mm	LION H35 TITAN 71/28" or 76/30"
MOD.	INNERCHOKES	+
	61/24"-66/26"-71/28"-76/30"	ADDITIONAL BARREL : SUPERGOOSE 90/36"
WOOD FINISH	TRIWOOD	
	• INTEGRALE	• SPECIFIC COMBO CASE (ABS)
KG	2,80 - 3,00	

(\*) With 2 3/4" ammunicions  
(\*\*) In accordance with legal constraints

A black nylon insert to improve the sighting. Un inserto in nylon nero per migliorare l'acquisizione della mira. Un insert en nylon noir pour améliorer la visée. Inserto de nylon para una mejora del encare. Entalhe em nylon, para facilitar o encare.

**GB** The LION H38 LUXE have been produced in reply to the demands of those who no longer wish to have to choose between functionality and looks. With its scrolls and its golden birds, the LION H38 LUXE is truly an object of great beauty. But the LION H38 LUXE stay, first of all, a real efficient shotgun made for an intensive use. Its PULSE® piston, its adjustable magazine capacity, its 100% titanium coating, its perfect weight and balance will give you the possibility to discover the complete potential of this new semi-auto generation.

**I** Il LION H38 LUXE è stato pensato per rispondere alle esigenze di tutti quei cacciatori che non vogliono dover scegliere tra funzionalità ed eleganza. Grazie alla piacevole incisione con i volatili rimessi in oro, il LION H38 LUXE è un bell'esempio d'arma fine. Il LION H38 LUXE è, prima di tutto un fucile molto efficiente, studiato per un uso intenso. Il pistone PULSE®, il serbatoio espandibile, il rivestimento in titanio, il suo bilanciamento ed il peso perfetto vi daranno la possibilità di scoprire tutto il potenziale di questa nuova generazione di semiautomatici.

**F** Le LION H38 LUXE a été pensé pour répondre aux attentes de toutes les personnes qui ne veulent plus avoir à choisir entre fonctionnalité ou élégance. Avec ses arabesques et oiseaux dorés, le LION H38 LUXE est vraiment une pièce d'une grande beauté. Mais le LION H38 LUXE reste, avant tout, un vrai fusil efficace conçu pour une utilisation intensive. Son piston PULSE®, sa capacité de magasin modulable, sa protection 100% titane, son poids et son parfait équilibre vous donnerons la possibilité de découvrir tout le potentiel d'un fusil semi-automatique «nouvelle génération».

**E** El modelo LION H38 LUXE ha sido la respuesta a las demandas de todos aquellos que no quieren elegir entre funcionalidad y estética. Con su grabado de "rosetas" y pájaros dorados la modelo LION H38 LUXE es realmente una escopeta de gran belleza. La nueva H38 LUXE es ante todo una escopeta efectiva diseñada para un uso intenso. Con el sistema PULSE PISTON, 100% protección titanio, su perfecto peso y balance hacen de este modelo una manera perfecta de descubrir la nueva generación de escopeta semi-automáticas.

**P** A LION H38 LUXE foi desenvolvida a pedido daqueles que não querem mais ter que optar entre funcionalidade e estética. Com os seus arabescos e o faisão e pato dourados, a LION H38 LUXE é um objecto de extrema beleza. Mas a LION H38 LUXE mantém-se, acima de tudo, como uma arma extremamente eficiente desenvolvida para um uso intenso. O pistão PULSE®, a capacidade regulável do carregador, o acabamento em titânio das peças, o seu peso e equilíbrio perfeitos dão-lhe a possibilidade de descobrir todo o potencial de uma arma semi-automática da "nova geração".



Delivered with 5 INNERCHOKES and 1 IN/OUT of 50 mm.  
Consegnato con 5 INNERCHOKES e 1 strozzatore IN/OUT da 50 mm.  
Livré avec 5 INNERCHOKES et 1 IN/OUT de 50 mm.  
Se envia con 5 INNERCHOKES y 1 IN/OUT de 50mm.  
Equipada com 5 INNERCHOKES e 1 IN/OUT de 50mm.



# LION H38 LUXE



LION H38 LUXE (OILED)



LION H38 LUXE  
(TRIWOOD)



**\*\*LION H38...3.6 or 8 SHOTS!**

LION H38 LUXE	
GAUGE	12/3" (12/76)
RIB (mm)	6
TOTAL CAPACITY*	3-6 OR 8
CHOKES	C-IC-M-IM-F + IN/OUT 50mm
MOD.	INNERCHOKES
	61/24" - 66/26" - 71/28" - 76/30"
	365
WOOD FINISH	OILED OR TRIWOOD
	• INTEGRALE™
KG	2,80 - 3,05

(\*) With 2 3/4" ammunitions

(\*\*) In accordance with legal constraints

INTEGRALE™  
CASE



Protection 100% titanium.  
Rivestimento al 100% in titanio.  
Traitement 100% titane.  
Tratamiento 100% titanium.  
Protecção 100% titânio.

**FABARM®**

**GB** When forms and functions come together, when ergonomomy and balance are the key-words. A shotgun made for intensive use with its full adjustable shooting capacity from 2+1 shotshells to 7+1 (in accordance with legal constraints). The PULSE® PISTON gives the possibility to shoot all types of ammunitions with an incredible reliability and comfort. Selected walnut with oil finish, a harmonious frame, the advanced technology... for a superb demonstration of the FABARM 'S know-how.

**I** Quando estetica e funzionamento sono abbinati, quando bilanciatura ed ergonomia sono la chiave vincente. Un semiautomatico nato per un uso intenso e modulare nella capacità del serbatoio, da 2+1 cartucce a 7+1 (in accordo con le varie disposizioni di Legge). Il PULSE® PISTON dà la possibilità di sparare tutti i tipi di cartucce con incredibile affidabilità e comfort. Legni in noce selezionata con finitura ad olio, carcassa con design armonioso, tecnologia avanzata e ricercata sono la dimostrazione dell'attuale know-how della FABARM.

**F** Lorsque formes et fonctions ne font qu'un, quand ergonomie et équilibre sont les mots-clé. Un fusil conçu pour une utilisation intensive avec sa capacité de tir totalement modulable de 2+1 cartouches à 7+1 cartouches (selon les législations en vigueur). Le piston PULSE® donne la possibilité de tirer tous les types de cartouches avec une incroyable fiabilité et confort. Noyer sélectionné avec finition huilée, une carcasse très harmonieuse, une technologie de pointe...pour une superbe démonstration du savoir-faire FABARM.

**E** Cuando las formas y la funcionalidad se juntan, cuando la ergonomía y el balance son las palabras clave, entonces nace la nueva LION H38. Una escopeta diseñada para un uso intensivo. El sistema PULSE® PISTON da la posibilidad de disparar todo tipo de munición con una increíble fiabilidad y confort. Madera de nogal seleccionada con acabado al aceite, tecnología avanzada, una auténtica demostración del know how de FABARM.

**P** Quando as formas e funções se encontram, quando a ergonomia e equilíbrio são as palavras-chave. Uma arma desenvolvida para o uso intensivo, com capacidade totalmente modulável de 2+1 cartuchos a 7+1 (conforme legislação vigente). O pistão PULSE® possibilita o disparo de todo o tipo de cartuchos com uma fiabilidade e conforto incrível. Madeiras em noqueira seleccionada, com acabamento a óleo, carcaça harmoniosa, uma tecnologia de ponta... para uma demonstração suprema do conhecimento e saber da FABARM.

# LION H38 HUNTER

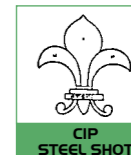

LION H38 HUNTER



A traditionnal oil finish.  
Legni finiti a olio.  
Une finition poncé - huilé.  
Acabado tradicional al aceite.  
Acabamento tradicional a óleo.

INTEGRALE™  
CASE



IN OPTION

PULSE® piston to regulate the reloading.  
Pistone PULSE® per regolare il ciclo di riarmo.  
Piston PULSE® pour réguler le réarmement.  
Sistema Piston PULSE® que sirve para regular la recarga.  
Cilindro PULSE®: regula o recuo e o rearme.

## \*\*LION H38... 3,6 or 8 SHOTS !

LION H38 HUNTER	
GAUGE	12/3" (12/76)
RIB (mm)	6
TOTAL CAPACITY*	3-6 OR 8
CHOKES	C-M-F
MOD.	INNERCHOKES
	61/24"-66/26"-71/28"-76/30"
	365
WOOD FINISH	OILED
	• INTEGRALE™
KG	2,80 - 3,05

(\*) With 2 3/4" ammunitions

(\*\*) In accordance with legal constraints

An adjustable shooting capacity from 3 to 6 or 8 shots.  
Una capacità totale da 3 a 6 o 8 colpi.  
Une capacité de tir ajustable de 3 à 6 ou 8 coups.  
Capacidad de tiro ajustable, de 3 a 8 u 8 tiros.  
Capacidade de tiro ajustável de 3, 6 ou 8 tiros.

## LION H38 38

OPTIONAL FABARM SCOPE MOUNT



Receiver grooves for scope mounting.  
Carcassa fresata per il montaggio di ottica.  
Fraisage du boîtier pour le montage d'optique.  
Estrías en la carcasa permiten montaje de elementos ópticos.  
Ranhuras na carcaça para montagem de mira.



IN OPTION

Fully adjustable shooting capacity.  
La capacità totale è facilmente espandibile.  
Capacité de tir modulable.  
Capacidad de tiro ajustable.  
Capacidade de tiro regulável.

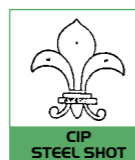



LION H38 SUPERGOOSE

LION H38 SLUG-DOX

LION H38 SOTTOBOSCO

\*\*LION H38... 3,6 or 8 SHOTS!

	LION H38 SUPERGOOSE	LION H38 SLUG DOX	LION H38 SOTTOBOSCO
GAUGE	12-3" (12/76)	12-3" (12/76)	12-3" (12/76)
RIB (mm)	8	ADJUSTABLE	SPECIFIC
TOTAL CAPACITY*	3-6 OR 8	3-6 OR 8	3-6 OR 8
CHOKES	XTREME RANGE	SLUG DOX	TULA
	90/36"	61/24" RIFLED (**)	61/24"
	365	365	365
FINISH	OILED	OILED	OILED
	• INTEGRALE™	• INTEGRALE™	• INTEGRALE™
KG	3,30	2,85	2,85

(\*) With 2 3/4" ammunitions  
(\*\*) In accordance with legal constraints  
(\*\*\*) Cyl on request

**GB** LION H38 SUPERGOOSE: Its TRIBORE® barrel, with Xtreme Range choke gives unequalled pattern results. This barrel, studied for lead and steel shot – delivered with a CIP steel shot proof test – has a unique internal profile with extra long cone. It pushes the limits of distance.

LION H38 SOTTOBOSCO: A compact, lightweight shotgun for short distance shots. The barrel is with a TULA choke.

LION H38 SLUG-DOX: An unequalled accuracy with its rifled ported barrel. The sights, with fibre optic insert are fully adjustable.

**I** LION H38 SUPERGOOSE: Questa canna, studiata per l'impiego sia con pallini in piombo che in acciaio, ha un profilo interno speciale, con coni di strozzatura molto lunghi che aumentano la portata utile del fucile.

LION H38 SOTTOBOSCO: un fucile leggero, agile e bilanciato per i tiri alla breve distanza. Canna con strozzatura TULA, ottimale nei tiri ravvicinati per ampiezza ed efficacia.

LION H38 SLUG-DOX: un'ineguagliabile precisione della canna internamente rigata e con volata "ported". Le mire realizzate con inserti in fibra ottica sono totalmente regolabili.

**F** LION H38 SUPERGOOSE: Son canon TRIBORE®, avec choke Xtreme Range permet des groupements sans égal. Ce canon, étudié pour le tir de plombs ou de grenaille d'acier – livré avec l'épreuve CIP billes d'acier – a un profil intérieur unique avec un cone extra long. Il repousse les limites de distance de tir.

LION H38 SOTTOBOSCO: Un fusil compact et léger pour les tirs à courte distance. Le canon possède un choke TULA.

LION H38 SLUG-DOX: Une inégalable précision avec son canon rayé porting. Les organes de visée, avec des inserts en fibre optique sont totalement réglables.

**E** LION H38 SUPERGOOSE: El cañón TRIBORE®, con choke Xtreme Range, proporciona unos plomeos sin comparación. El cañón TRIBORE® tiene una diseño interna único con un cono extra largo. Es perfectamente válido tanto para cartuchos de plomo como de perdigón de acero – se envía certificado con prueba CIP.

LION H38 SOTTOBOSQUE, escopeta compacta, ligera, ideal para las distancias cortas. El cañón incorpora choke tipo TULA.

LION H38 SLUG-DOX, increíble precisión del cañón estriado, miras de fibra óptica completamente ajustables.

**P** LION H38 SUPERGOOSE: O cano TRIBORE®, com chokes Xtreme Range permite distribuições de tiro inigualáveis. Este cano, preparado para o tiro com esferas de chumbo e de aço – contém prova CIP de teste com esferas de aço – tem um perfil interno único, com um cone extra longo. Ultrapassa os limites convencionais da distância

LION H38 SOTTOBOSCO: Uma arma compacta, leve, para tiros a curta distância. O cano está equipado com choke TULA.

LION H38 SLUG-DOX: Uma prestação inigualável com este cano raiado ported. Os pontos de mira com inserção em fibra óptica são totalmente ajustáveis.

INTEGRALE™  
CASE

**FABARM®**



**GB** The choice of materials makes this LION H368 particularly suited for waterfowl hunting or for use in rougher conditions. The stock and the forend are response composite. Both models have our exclusive SOFT TOUCH finish to optimize the grip in all weather conditions. The TRIBORE® barrel are with INNERCHOKES 100% titanium protected, the ultimate answer for steel shot. IN/OUT choke tubes that extend the barrel to increase its range can be also fitted.

**I** I materiali impiegati nella fabbricazione del LION H368, lo rendono particolarmente adatto per la caccia agli acquatici e per l'uso nelle condizioni più dure. Calcio ed astina sono realizzati in materiale sintetico. I tre modelli impiegano la finitura SOFT TOUCH per migliorare la presa anche in condizioni critiche d'utilizzo. La canna TRIBORE® monta strozzatori rivestiti in titanio, molto efficienti anche con le cartucce a pallini d'acciaio. Per migliorare sensibilmente la resa balistica della canna, si possono montare anche gli strozzatori IN/OUT.

**F** Les matériaux utilisés font de ce LION H368 une arme particulièrement adaptée à la chasse au gibier d'eau ou dans des conditions difficiles. La crosse et le garde-main sont en composite. Chaque modèle a aussi notre finition SOFT TOUCH exclusive, afin d'optimiser la prise en main dans toutes les conditions climatiques. Le canon TRIBORE® avec INNERCHOKES à protection 100% titane est l'ultime réponse pour la grenaille d'acier. Des chokes IN/OUT qui prolongent le canon peuvent aussi être montés.

**E** Los materiales usados en el modelo LION H368 le hacen ser una escopeta específicamente preparada para caza de aves acuáticas o para uso en las condiciones atmosféricas más duras. Culata y delantera son de material sintético. Ambos modelos tienen nuestro acabado exclusivo SOFT TOUCH para optimizar el agarre en cualquier condición. El tubo TRIBORE® presenta innerchokes cubiertos al 100% con titanio, la última propuesta para tiro con cartuchos de acero. Adaptable chokes IN/OUT que permiten incrementar la longitud del cañón.



**P** Os materiais utilizados, tornam estas LION H368 particularmente adaptadas à caça às aves aquáticas ou em condições extremas. A coronha e o fuste são em composto. Ambos os modelos têm o nosso acabamento exclusivo, SOFT TOUCH para otimizar a aderência em todas as condições atmosféricas. O cano TRIBORE®, com INNERCHOKES 100% revestidos a titânio, é a mais recente solução para tiros com esferas de aço. Podem ser utilizados chokes IN/OUT para aumentar o comprimento do cano.

# LION H368 368



LION H368 MAX 4

**\*\*LION H368... 3,6 or 8 SHOTS !**

	LION H368 UNITED CAMO	LION H368 MAX 4	LION H368 COMPOSITE
GAUGE	12-3" (12/76)	12-3" (12/76)	12-3" (12/76)
RIB (mm)	6	6	6
TOTAL CAPACITY*	3-6 OR 8	3-6 OR 8	3-6 OR 8
CHOKES	C-M-F	C-M-F	C-M-F
MOD.	INNERCHOKES	INNERCHOKES	INNERCHOKES
	66/26"-71/28"-76/30"	71/28"-76/30"	66/26"-71/28"-76/30"
	355	355	355
FINISH	HARDWOODS GREEN HD + SOFT	ADVANTAGE MAX 4 + SOFT	COMPOSITE + SOFT
	•	•	•
KG	2,90 - 3,10	3,00 - 3,10	2,80 - 3,10

(\*) With 2 3/4" ammunitions  
(\*\*) In accordance with legal constraints



LION H368 UNITED CAMO



LION H368 COMPOSITE

CASE



Specific SOFT TOUCH finish to optimize the grip.  
L'esclusivo rivestimento SOFT TOUCH per migliorare la presa delle mani.  
Finition spécifique SOFT TOUCH pour optimiser la prise en main.  
Tratamiento específico SOFT TOUCH para un agarre perfecto.  
Acabamento SOFT TOUCH, para otimizar a aderência.



Receiver grooves for scope mounting.  
Carcassa fresata per il montaggio di un'ottica.  
Fraisage du boîtier pour le montage d'optique.  
Estrías en la carcasa permiten montaje de elementos ópticos.  
Ranhuras na carcaça para montagem de mira.



An adjustable shooting capacity from 3 to 6 or 8 shots.  
Una capacità totale da 3 a 6 o 8 colpi.  
Une capacité de tir ajustable de 3 à 6 ou 8 coups.  
Capacidad de tiro ajustable, de 3 a 8 u 8 tiros.  
Capacidade de tiro ajustável de 3, 6 ou 8 tiros.

## LEFT HANDED



Optic fiber insert on the LION H35 AZUR LEFT HAND frame.  
 Inserto in fibra ottica sulla carcassa LION H35 AZUR LEFT HAND.  
 Insert en fibre optique sur le boîtier du LION H35 AZUR LEFT HAND.  
 Insertos en fibra óptica en la carcasa de LION H35 AZUR LEFT HAND.  
 Entalhe de fibra óptica na LION H35 AZUR LEFT HAND.





LION H38 REVERSE:  
 A traditional oil finish.  
 Legni finiti a olio.  
 Une finition poncé - huilé.  
 Acabado tradicional al aceite.  
 Acabamento tradicional a óleo.



LION H38 REVERSE

LION H35  
AZUR LEFT-HANDLION H368  
COMPOSITE LEFT-HAND

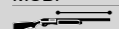
LION H368 COMPOSITE LEFT:  
 Specific SOFT TOUCH finish to optimize the grip.  
 L'esclusivo rivestimento SOFT TOUCH per migliorare la presa delle mani.  
 Finition spécifique SOFT TOUCH pour optimiser la prise en main.  
 Tratamiento específico SOFT TOUCH para un agarre perfecto.  
 Acabamento SOFT TOUCH, para optimizar a aderência.

	LION H38 REVERSE	LION H35 AZUR LEFT HAND	LION H368 COMPOSITE LEFT HAND
GAUGE	12-3" (12/76)	12-3" (12/76)	12-3" (12/76)
RIB (mm)	6	6	6
TOTAL CAPACITY*	3-6 or 8 (**)	3 or 5 (**)	3-6 or 8 (**)
CHOKES	C-IC-M-IM-F	C-IC-M-IM-F + IN/OUT 50mm	C-IC-M-IM-F
MOD.	INNERCHOKES	INNERCHOKES	INNERCHOKES
	61/24"-66/26"-71/28"-76/30"	61/24"-66/26"-71/28"-76/30"	66/26"-71/28"-76/30"
	365	365	355
FINISH	OILED	TRIWOOD 100	COMPOSITE + SOFT
	• INTEGRALE™	• ESTHETE	•
KG	2,80 - 3,00	2,80 - 3,00	2,80 - 3,10

(\*) With 2 3/4" ammunitions  
 (\*\*) In accordance with legal constraints

GB These shotguns are the only left handed shotguns gas-operating manufactured in Europe. These three versions cover all the needs of hunters, from a black composite shotgun to the luxurious AZUR specifications. Possibility to increase the magazine tube capacity with an extension on the LION H38 REVERSE and LION H368 COMPOSITE.

I Questi fucili sono gli unici a sottrazione di gas prodotti in Europa per tiratori mancini. Le tre versioni previste soddisfano tutte le esigenze e necessità dei cacciatori mancini, dal modello nero Composite all'elegante e prestigioso AZUR. Nelle versioni LION H38 REVERSE e LION H368 COMPOSITE è possibile aumentare la capacità del serbatoio.

F Ces armes sont les seuls fusils semi-automatiques gauchers à emprunt de gaz fabriqués en Europe. Ces trois versions couvrent tous les besoins des chasseurs, du fusil composite aux luxueuses caractéristiques de l'AZUR. Possibilité d'augmenter la capacité du tube magasin avec une prolonge sur le LION H38 REVERSE et le LION H368 COMPOSITE.

E Estas escopetas son las únicas escopetas que operan con el sistema de gas fabricadas en Europa especialmente para zurdos. Estas tres versiones cubren todas las necesidades de los cazadores, incluyendo la lujosa versión del modelo AZUR para zurdos.

P Estas armas são as únicas esquerdas com extracção por gás fabricadas na Europa. As três versões apresentadas cobrem todas as necessidades do caçador, desde o modelo em composto até às luxuosas características da AZUR. Possibilidade de aumentar a capacidade do tubo carregador com uma extensão na LION H38 REVERSE e na LION H368 COMPOSITE.

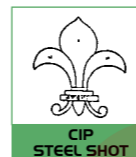

# CHOKES/TUBES

■ **INNER HP™**  
cal. 12  
cal. 20  
cal. 28

SHORT 2/10 HP    MEDIUM 5/10 HP    LONG 7/10 HP    XTREME 9/10 HP

■ **EXIS HP™**  
cal. 12

SKEET CYL    SHORT 2/10 HP    MEDIUM 5/10 HP    LONG 7/10 HP    XTREME 9/10 HP

■ **INNERCHOKES**  
cal. 12  
cal. 20

CYLINDER    ★★★★★ IMP.CYL    ★★★ MODIFIED    ★★ IMP. MOD.    ★ FULL

■ **EXIS**  
cal. 12

CYLINDER    ★★★★★ SKEET    ★★★★★ IMP.CYL    ★★★ LIGHT MOD.    ★★ MODIFIED    ★★ IMP. MOD.    ★ LIGHT FULL    ★ FULL

■ **INNER HP™ PARADOX RIFLED**  
cal. 12  
cal. 20

■ **INNER HP™ ULTIMATE 12/10**  
cal. 12  
cal. 20

■ **IN-OUT**  
cal. 12

★★★★ IMP.CYL    ★★★ MODIFIED    ★★ IMP. MOD.    ★ FULL    14/10 SUPER FULL

OUT in mm    30    50    75    100    120

■ **MULTICHOKES**  
cal. 12

CYLINDER    ★★★★★ IMP.CYL    ★★★ MODIFIED    ★★ IMP. MOD.    ★ FULL

LENGTH in mm    0    30    50    75    100

# POLICE-LE.



**SEMI-AUTO PUMP**

**GB** The S.A.T. 8 has been designed for dynamic shooting and law enforcement. In the butt stock there are no moving parts that could change the center of gravity when the gun is fired. Equipped with a Picatinny rail on the frame, with a ghost sight fully adjustable for elevation and windage, the front sight is inserted with an adjustable optic fiber. The muzzle of the barrel is threaded in order to fit our MULTICHOKES or muzzle break.

**I** Il modello S.A.T. 8 è stato studiato per il tiro dinamico sportivo con arma lunga e per impieghi di polizia e di difesa abitativa. Nel calcio non ci sono parti in movimento che possono cambiare il baricentro dell'arma al momento dello sparo; questa soluzione tecnica consente d'avere in mano un'arma molto stabile. Equipaggiato con due Picatinny rail, sul castello viene montata una diottra ghost sight regolabile in altezza e deriva, il mirino anteriore è in fibra ottica. La bocca della canna è filettata per potere accogliere gli strozzatori esterni MULTICHOKES o il freno di bocca.

**F** Le S.A.T.8 a été conçu pour le tir dynamique (IPSC) et pour un usage professionnel par les forces d'intervention. Aucune pièce mobile ne se trouvant dans la crosse, le centre de gravité de l'arme n'est pas modifié en action de tir. Un rail Picatinny est fixé sur la carcasse avec une hausse à œillette réglable en hauteur et dérive, le guidon réglable est avec un insert en fibre optique. La bouche du canon est fileté pour permettre le montage des MULTICHOKES ou d'un frein de bouche.

**E** El modelo S.A.T. 8 ha sido ideado para un tiro dinámico deportivo con arma larga y para uso policial. En la culata no existen piezas móviles que puedan cambiar el centro de gravedad del arma en el momento del disparo; esta solución técnica permite que el arma esté más estable entre las manos. Equipado con un rail Picatinny regulable en altura y deriva, y un punto de mira anterior con un inserto en fibra óptica para mejorar la visibilidad. La boca del cañón está roscada para poder acoger los casquillos externos MULTICHOKES o un freno de boca.

**P** A S.A.T. 8 foi concebida para o tiro dinâmico (IPSC) e para o uso profissional das Forças da Lei. Não há peças móveis dentro da coronha, logo o centro de gravidade da arma permanece estável durante o tiro. Na carcassa, tem fixado um rail Picatinny, com um ponto de mira totalmente ajustável em altura e profundidade e com um entalhe em fibra óptica. A rosca do cano, permite a colocação de MULTICHOKES.

S.A.T. 8



S.A.T. 8 PRO FORCES



S.A.T. 8 PRO TELESCOPIC



S.A.T. 8 TACTICAL

	S.A.T. 8 PRO FORCES	S.A.T. 8 PRO TELESCOPIC	S.A.T. 8 TACTICAL
GAUGE	12-3" (12/76)	12-3" (12/76)	12-3" (12/76)
CHOKES	51/20"	51/20"	51/20"
CAPACITY*	MULTICHOKE (C) **	MULTICHOKE (C) **	MULTICHOKE (C) **
	7+1 ***	7+1 ***	7+1 ***
FINISH	MAT BLACK	MAT BLACK	MAT BLACK
	PRO FORCES	TELESCOPIC	PISTOL
MATERIAL	TACTICAL	TACTICAL	TACTICAL
	COMPOSITE	COMPOSITE	COMPOSITE
	320	308-385	355
KG	3,20	3,30	3,15

(\*) With 2 3/4" ammunitions (\*\*) Muzzle break included (\*\*\*) In accordance with legal constraints



A specific long cocking handle rubber protected.  
La pratica manetta d'armamento rivestita in gomma.  
Doigt d'armement spécifique plus long et revêtu de caoutchouc.  
Manilla de montaje larga y cubierta con goma.  
Um puxador especificamente longo revestido a borracha.

Windage and elevation adjustment ghost sight.  
Ghost Sight completamente regolabile.  
Réglage vertical et latéral de la hausse à œillette.  
Mira regulable en altura y lateralidad.  
Alça de mira com regulação vertical e horizontal.

## PUMP PRO



**GB** At FABARM we know that the SDASS shotgun is not just a weapon, it's a tool. With the SDASS you have in hand a shotgun which is suitable with all types of ammunitions: slug, buckshots, less-lethal, gas, propulsive etc....

**I** Alla FABARM sappiamo che il nostro SDASS non è un semplice fucile, ma un vero e proprio attrezzo da lavoro. Con lo SDASS avete fra le mani un fucile che funziona con tutti i tipi di munizioni: palla, pallettoni, cartucce non letali.

**F** Chez FABARM nous savons que le fusil SDASS n'est pas seulement une arme, c'est un outil. Avec le SDASS vous avez en main un fusil qui permet l'utilisation de tous les types de munitions: slug, chevrotines, non létal, à gaz, propulsive etc....

**E** En FABARM sabemos que la escopeta SDASS no es sólo un arma, es una herramienta de trabajo. Con los modelos SDASS dispone de un arma que puede utilizarse con todos tipos de munición: postas, buckshot (posta zorrera), less-lethal, gas, propulsive... etc.

**P** Na FABARM sabemos que uma SDASS, não é apenas uma arma, é uma ferramenta. Com a SDASS tem uma arma capaz de utilizar qualquer tipo de munições: cartucho bala, zagalotes, munições borracha, gás, propulsivas, etc....

SDASS PRO FORCES

SDASS TACTICAL

SDASS PRO TELESCOPIC

	SDASS PRO FORCES	SDASS TACTICAL	SDASS PRO TELESCOPIC	MARTIAL PRO FORCES **	MARTIAL TACTICAL **	MARTIAL PRO TELESCOPIC **
GAUGE	12-3" (12/76)	12-3" (12/76)	12-3" (12/76)	12-3" (12/76)	12-3" (12/76)	12-3" (12/76)
 CHOKES	51/20"	51/20"	51/20"	51/20"	51/20"	51/20"
 CAPACITY	MULTICHOKE (C)	MULTICHOKE (C)	MULTICHOKE (C)	MULTICHOKE (C)	MULTICHOKE (C)	MULTICHOKE (C)
 FINISH	7+1*	7+1*	7+1*	5+1*	5+1*	5+1*
 MATERIAL	MAT BLACK	MAT BLACK	MAT BLACK	MAT BLACK	MAT BLACK	MAT BLACK
 MATERIAL	PRO FORCES	PISTOL	TELESCOPIC	PRO FORCES	PISTOL	TELESCOPIC
 MATERIAL	TACTICAL	TACTICAL	TACTICAL	TACTICAL	TACTICAL	TACTICAL
 MATERIAL	COMPOSITE	COMPOSITE	COMPOSITE	COMPOSITE	COMPOSITE	COMPOSITE
 MATERIAL	320	355	308-385	320	355	308-385
 MATERIAL	•	•	•	•	•	•
KG	3,05	3,00	3,20	3,00	2,95	3,15

(\*) With 2 3/4" ammunitions (\*\*) Product non shown



Windage and elevation adjustment ghost sight with a Picatinny rail.  
Ghost sight completamente regolabile e slitta Picatinny.  
Règlage vertical et latéral de la hausse à oeillette et rail Picatinny.  
Mira regulable en altura y lateralidad con rail Picatinny.  
Alça de mira com regulação vertical e horizontal e Rail Picatinny.



A spring in the forend mechanism help the reloading.  
Una molla nel meccanismo dell'astina velocizza il riarmo.  
Un ressort dans le mécanisme du garde-main facilite le réarmement.  
Un muelle en el mecanismo de la delantera que facilita la recarga.  
Uma mola no mecanismo do fuste, facilita o rearme.

SDASS



SDASS COMPOSITE 20"



SDASS HEAVY COMBAT 20"



SDASS TRAINER 20"



SDASS TRAINER NICKEL 20"

SDASS TRAINER KARBON 20"

SDASS SHORT 20"

SDASS COMPACT 20"

	SDASS COMPOSITE 20"	SDASS HEAVY COMBAT 20"	SDASS TRAINER 20"	SDASS TRAINER KARBON 20"	SDASS TRAINER NICKEL 20"	SDASS COMPACT 20"	SDASS SHORT 20"
GAUGE	12-3" (12/76)	12-3" (12/76)	12-3" (12/76)	12-3" (12/76)	12-3" (12/76)	12-3" (12/76)	12-3" (12/76)
CHOKE	51-20"	51/20"	51/20" COOLING JACKET	51/20" COOLING JACKET	51/20" COOLING JACKET	51/20"	51/20"
CAPACITY	MULTICHOKE (C)	MUZZLE BREAK + MULTI (C)	MULTICHOKE (C)	MULTICHOKE (C)	MULTICHOKE (C)	MULTICHOKE (C)	MULTICHOKE (C)
FINISH	7+1 *	7+1 *	7+1 *	7+1 *	7+1 *	7+1 *	7+1 *
MATERIAL	MAT BLACK	MAT BLACK	MAT BLACK	KARBON FINISH	NICKELED	MAT BLACK	MAT BLACK
	PISTOL	PRO FORCES	PISTOL	PISTOL	PISTOL	FOLDING STOCK	PISTOL GRIP
	TACTICAL	TACTICAL	TACTICAL	TACTICAL	TACTICAL	TACTICAL	TACTICAL
	COMPOSITE	COMPOSITE	COMPOSITE	COMPOSITE	COMPOSITE	COMPOSITE	COMPOSITE
	355	320	355	355	355	/	/
	CARTON BOX	CARTON BOX	CARTON BOX	CARTON BOX	CARTON BOX	CARTON BOX	CARTON BOX

(\*) With 2 3/4" ammunitions

GB

A pump shotgun with quality criteria "Made in Italy". The SDASS, chambered 12M, with a 7+1 shot capacity, is fully suitable for all types of ammunition (pellets, slug, gas etc...). All the barrels are TRIBORE®. With its perfect reliability, its fluid and speed mechanism, the SDASS has also several key parts with a special high tech PVD coating (bolt, carrier, trigger etc...) ...simply the best!

F

Une arme à pompe avec des critères de qualité "Made in Italy". Le SDASS, chamberé en calibre 12M, d'une capacité de tir de 7+1 cartouches accepte parfaitement toutes les munitions, à grenaille, balle, gaz etc... Tous les canons sont TRIBORE®. D'une fiabilité sans faille, rapide et fluide, le SDASS possède de nombreuses pièces avec un traitement de surface PVD (culasse, éleveur, détente etc...) ...le nec plus ultra!

I

Un fucile a pompa con tutti i criteri di qualità tipici del "Made in Italy". Lo SDASS è camerato 12/76, con una capacità pari a 7+1 cartucce e spara tutti i tipi di munizioni (a pallettoni, a palla, munizionamento in gomma non letale etc...). Tutte le canne sono TRIBORE®. Con la sua perfetta efficienza, la sua azione fluida e velocissima, lo SDASS può contare su diverse parti meccaniche con finitura in PVD (otturatore, elevatore e grilletto) che garantisce una eccezionale resistenza alla corrosione.

E

Una escopeta de corredera con todos los criterios de calidad típica del "Made in Italy". La escopeta SDASS tiene recámara Magnum 12/76, con una capacidad de 7+1 cartuchos, disparando todo tipo de cartuchos (postas, bala, munición de goma no letal). Todos los cañones son TRIBORE®. Su perfecta eficiencia y con su acción fluida y velocísima, la escopeta SDASS, puede llevar diversos componentes mecánicos terminados en PVD (cerrojo, transportador, disparador) que garantizan una excepcional resistencia a la oxidación.

P

Uma arma pump, com os critérios de qualidade "Made in Italy". A SDASS, com câmara calibre 12, capacidade de tiro de 7+1 cartuchos, aceita perfeitamente todo o tipo de munições (chumbos, zagalotes, gás, etc...). Todos os canos são TRIBORE®. Com uma fiabilidade sem falhas, rápida e fluida, a SDASS possui diversos componentes com acabamento hi-tech (Coronha, elevador, gatilho, etc...) ... simplesmente a melhor!

## MARTIAL



MARTIAL COMPOSITE 18"



Suitable for all types of ammunition in 12 Ga.  
 Funzionamento ineccepibile con tutti i tipi di cartucce calibro 12.  
 Fonctionne parfaitement avec tous les types de munitions calibre 12.  
 Funcionamiento sin excepción con todo tipo de cartucho del calibre 12.  
 Funcionamento perfeito com todo o tipo de munições cal.12.



MARTIAL ULTRA SHORT 14"



MARTIAL SHORT 18"

A strong folding stock very handy.  
 Un solido calcio pieghevole per utilizzare l'arma con una sola mano.  
 Une solide crosse rabattable avec une main seulement.  
 Una sólida culata retráctil que permite la utilización de la escopeta con una sola mano.  
 Uma coronha rebatível sólida e fácil de usar com uma mão.



MARTIAL COMPACT 18"

	MARTIAL COMPOSITE 18"	MARTIAL ULTRA SHORT 14"	MARTIAL COMPACT 18"	MARTIAL SHORT 18"
GAUGE	12-3" (12/76)	12-3" (12/76)	12-3" (12/76)	12-3" (12/76)
CHOKE	46/18" *	36/14" COOLING JACKET	46/18" *	46/18" *
CAPACITY	5+1 **	5+1 **	5+1 **	5+1 **
FINISH	MAT BLACK	MAT BLACK	MAT BLACK	MAT BLACK
	PISTOL	GRIP	FOLDING STOCK	GRIP
MATERIAL	TACTICAL	TACTICAL	TACTICAL	TACTICAL
	COMPOSITE	COMPOSITE	COMPOSITE	COMPOSITE
	355	/	/	/
	CARTON BOX	CARTON BOX	CARTON BOX	CARTON BOX

(\*) Also available with 20" barrel multi (\*\*) With 2 3/4" ammunitions

**I** Il MARTIAL 6 colpi è prima di tutto un fucile a pompa molto compatto. Leggero, spara facilmente ogni tipo di cartuccia. A seconda dell'uso che intendete farne, potete acquistarlo con calcio sintetico, in legno oppure con la sola impugnatura a pistola; in questo caso, si dimostra perfetto quando lo spazio dove collocarlo è minimo, avendo una lunghezza totale pari a 61 cm.

**GB** The MARTIAL 6 shots is first of all a compact pump shotgun. Lightweight, it can shoot every kind of ammunition. Depending upon your use, you can choose the composite, wood, compact or short version. This last one, perfect with a limited storage space, is only 24" (61 cm) in length.

**F** Le MARTIAL est avant tout un fusil à pompe compact. Léger, il peut tirer tous les types de munitions. Selon votre usage vous pouvez opter pour la version composite, bois, compact ou short. Cette dernière, parfaite chaque fois que l'espace de rangement est limité, a une longueur totale de seulement 24" (61 cm).

**E** La escopeta MARTIAL tiene una capacidad de 6 cartuchos; es una escopeta de corredera muy compacta, ligera y versátil, que permite disparar cualquier tipo de cartucho. En función del uso que se vaya a hacer de la escopeta, se puede suministrar con culata en nylon, en madera, o simplemente con empuñadura o pistolero; este caso es el más adecuado cuando el espacio donde debe ser colocada es mínimo, porque su longitud no supera los 61 cm.

**P** A MARTIAL é antes de mais, uma arma pump compacta. Ligeira, pode disparar todo tipo de munições. Consoante a aplicação, pode escolher a versão em composto, madeira, compacta ou curta. Esta última, é perfeita em situações em que o espaço de armazenamento é limitado a um comprimento total de 61 cm.

# ACCESSORIES

## Asper Scope Mount



- 4 001 163 ASPER SCOPE MOUNT 1"
- 4 001 165 ASPER SCOPE MOUNT 30 mm
- 4 001 166 ASPER SCOPE MOUNT FOR ZEISS RAIL
- 4 001 167 ASPER SCOPE MOUNT FOR SWAROVSKI RAIL
- 4 001 208 ASPER SCOPE MOUNT WITH WEAVER RAIL

## Semi-Auto Scope Mount



B-072 FABARM SCOPE MOUNT

## Magazine extension



F-113-A MAGAZINE EXTENSION FOR LION H38 & LION H368 (WITH SLING SWIVEL.)

## Pads & spacers

### For Wooden stock



- A-053 INTERCHANGEABLE RUBBER RECOIL PAD 12 MM
- A-057 INTERCHANGEABLE RUBBER RECOIL PAD 22 MM
- A-056 INTERCHANGEABLE OILED WALNUT PAD 12 MM

### For Composite stocks



- A-049 PAD SPACER 5 MM
- A-050 PAD SPACER 10 MM

## Muzzle Break



E-023-A FABARM MUZZLE BREAK (for MULTICHOKE barrel)

# GUN OIL & CLEANER

## GUN OIL SPRAY



SPRAY 125 ml  
OSPI50 GUN OIL SPRAY 125 ml

## GUN OIL NO GAS



PUMP 125 ml  
OPI25 GUN OIL PUMP 125 ml

## GUN CLEANER



GCI25 SOLVENT SPRAY 125 ml.



- DELIVERED IN CARTON DISPLAY:
- GUN OIL SPRAY
  - GUN OIL NO GAS
  - SOLVENT SPRAY





# GUN SLIPS

AGILIS OVERSIZED RS 146

AGILIS REGULAR RS 132

AGILIS SCOPED RS 110

AGILIS PUMP RS 115



CODE	MODEL	MATERIAL	COLOUR	MAXIMUM BARREL SIZE
RS132	AGILIS REGULAR	CORDURA 600/CANVAS	LODEN/OLIVE	SEMI-AUTO 76 cm (30") - BREAK DOWN 81 cm (32")
RS146	AGILIS OVERSIZED	CORDURA 600/CANVAS	LODEN/OLIVE	SEMI-AUTO 90 cm (36") - ALL BREAK-DOWN
RS110	AGILIS SCOPED	CORDURA 600/CANVAS	LODEN/OLIVE	ASPER or RIFLE with scope
RS115	AGILIS PUMP	CORDURA 600	BLACK/NAVY	PUMP 51 cm. (20")

**BREAK-DOWN:**  
 OVER & UNDER - SIDE BY SIDE  
 SOVRAPPOSTI - DOPPIETTE  
 SUPERPOSES - JUXTAPOSES

# GUN CASES

LEATHER CASES

ESTHETE™ CASES

ALUMINIUM CASES

INTEGRALE™ CASES



CODE	MODEL	MATERIAL	MAXIMUM BARREL LENGTH
430A/AUT	LEATHER 5A	LEATHER	SEMI-AUTO 76 cm (30")
430A-76	LEATHER B/D	LEATHER	BREAK-DOWN SHOTGUNS 76cm (30")
368-AUT	ESTHETE 5A	SPALMATO	SEMI-AUTO 76 cm (30")
368-76I	ESTHETE B/D	SPALMATO	BREAK-DOWN SHOTGUNS 76cm (30") INNER HP CHOKE
368-EXPI3	ESTHETE EXPRESS	SPALMATO	FOR ASPER RIFLE WITH SCOPE
SG57238-A	ALUMINIUM EXPRESS	ALUMINIUM	FOR ASPER RIFLE 55cm (22")
SG57249-A	ALUMINIUM B/D	ALUMINIUM	BREAK-DOWN SHOTGUNS 81cm (32")
SG56252	INTEGRAL 5A	SYNTHETIC	SEMI-AUTO 90 cm (36")
SG56247	INTEGRAL B/D	SYNTHETIC	BREAK-DOWN SHOTGUNS 81cm (32")

ESTHETE™ EXPRESS

INTEGRALE™ BREAK-DOWN

INTEGRALE™ SEMI-AUTO

**BREAK-DOWN:**  
 OVER & UNDER - SIDE BY SIDE  
 SOVRAPPOSTI - DOPPIETTE  
 SUPERPOSES - JUXTAPOSES



## CLOTHING

## ■ SUPERLATIVE VEST



## ■ SIGNATURE CAP



100% MADE IN ITALY

CODE	MODEL	SIZE	FABRIC	COLOUR	FEATURES
PSV07.	SUPERLATIVE VEST	S - M - L - XL - XXL	WOOL/VISCOSE	NAVY - TAN - BROWN	AMBIDEXTROUS
SC07KU	SIGNATURE CAP	UNIQUE	TWILL COTTON	KHAKI	ADJUSTABLE